



WARRANTY * INSTALLATION * CARE

Nail Down/Nail Glue-Assist Glue Down – Wall



Engineered Hardwood Flooring
Plywood Core

LIMITED RESIDENTIAL CONSUMER WARRANTY

Builders Pride - Virginia Millworks - Mayflower Engineered Hardwood Flooring Products

For Commercial Limited Warranty [click here](#)

THIS LIMITED WARRANTY GIVES YOU SPECIFIC LEGAL RIGHTS, AND YOU MAY ALSO HAVE OTHER RIGHTS, WHICH VARY FROM STATE TO STATE.

THIS LIMITED WARRANTY CONTAINS ARBITRATION AND CLASS ACTION WAIVER PROVISIONS (SEE BELOW IN SECTION 9). THIS LIMITED WARRANTY ALSO CONTAINS LIMITATIONS OF LIABILITY (SEE BELOW IN SECTION 8).

WE LIMIT THE DURATION AND REMEDIES OF ALL EXPRESS OR IMPLIED WARRANTIES, INCLUDING WITHOUT LIMITATION THE WARRANTIES OF MERCHANTABILITY AND FITNESS FOR A PARTICULAR PURPOSE TO THE DURATION OF THIS EXPRESS LIMITED WARRANTY (SEE SECTION 2).

SOME STATES AND JURISDICTIONS DO NOT ALLOW LIMITATIONS ON HOW LONG AN IMPLIED WARRANTY LASTS, SO THE ABOVE LIMITATION MAY NOT APPLY TO YOU.

OUR RESPONSIBILITY FOR DEFECTIVE GOODS IS LIMITED TO THE STORE CREDIT AS DESCRIBED BELOW IN THIS LIMITED WARRANTY STATEMENT.

[warranty information continues on following page]

1. WHO MAY USE THIS LIMITED WARRANTY?

LL Flooring, Inc. (“we,” “us,” and “our”) extends this limited warranty only to the consumer who originally purchased the product (“you”) and only for residential use. It does not extend to any subsequent owner or other transferee of the product. **THIS LIMITED WARRANTY IS NOT TRANSFERABLE. THE LIMITED WARRANTY EXTENDS ONLY TO THE ORIGINAL END-CONSUMER.** For purposes of this limited warranty, a “residential use” is a product installation at a single-family home, apartment unit, townhouse, or other place where people live and, notwithstanding the forgoing list, excludes: (a) multi-family housing common areas; (b) any real estate property that is used for business or commercial activities; (c) any location used in whole or in part for business or commercial purposes; and (d) any location where foot traffic exceeds normal, residential foot traffic. We have the sole right to make the determination of whether an application is a residential use or another kind of use. For purposes of such determination, we may need to visit the location that relates to the warranty claim for inspection and use. This limited warranty does not apply to any commercial / industrial use.

2. WHAT IS THE PERIOD OF COVERAGE?

Subject to the requirements listed in Section 5 below, this limited warranty starts on the date of your purchase and lasts for the time period set forth in the chart below for your specific product (the “Limited Warranty Period”):

Product Identification	Limited Warranty Period
Builders Pride	50 Years
Virginia Millworks	50 Years
Mayflower	30 Years
Mayflower	10 Years as Specified

If, for any reason, we repair or replace the product, the Limited Warranty Period is not extended. We may change the availability and duration of this limited warranty at our discretion, but any changes will not be retroactive.

Where the Limited Warranty Period noted above provides for a “Lifetime” warranty, the duration of this limited warranty shall be the lifetime of the original purchaser so for as long as they own the flooring.

3. WHAT DOES THIS LIMITED WARRANTY COVER?

During the Limited Warranty Period and subject to the complete terms of this limited warranty, this limited warranty covers the following product aspects from defects in materials and workmanship of the purchased product (the “product”):

- **Limited Finish Wear Warranty.** Finish wear from normal residential use conditions resulting in the exposure of the bare wood or bamboo, subject to the exclusions provided in Section 4 below.

- *Defects Included in Waste Factor.* Manufacturing and natural defects in excess of the Waste Factor (defined below). For purposes of this limited warranty, “Waste Factor” shall mean the allowance for manufacturing and natural defects in flooring and is represented by a percentage—namely, that: (i) no more than 5% of the total square footage of your purchase of 1st-grade, 2nd-grade, natural, select, and clear grade products; (ii) no more than 20% of the total square footage of your purchase for 3rd-grade, common, rustic, mill run, and mixed-grade; (iii) no more than 25% of the total square footage of your purchase of cabin grade, tavern grade, and utility grade products. For purposes of clarity, the Waste Factor does not relate to product waste caused by your cutting the product for your intended project or use. Rather, the Waste Factor relates to the stated percentage of the product as purchased that a purchaser can expect to have manufacturing or natural defects. Your cutting allowance (that is, the inherent waste created by your cutting the product) is not a defect or deficiency and will depend on your project and your use of the materials.
- *Delamination.* The product will not delaminate under normal residential use conditions.

4. WHAT DOES THIS LIMITED WARRANTY NOT COVER?

This limited warranty does not cover any defects or damages due to: (a) failure to strictly follow the Installation and Care Requirements (defined and discussed below) regardless of the installer; (b) transportation; (c) storage; (d) improper use; (e) modifications; (f) unauthorized repair; or (g) external causes such as accidents, abuse, or other actions or events beyond our reasonable control. In addition, this limited warranty does not cover any defects or damages due to the following:

- *Moisture (or Lack of Moisture).* Damages caused by moisture (such as leaking pipes, spills, wet mopping, pets, relative humidity, subfloor moisture etc.) are excluded. Moisture (and dryness) can cause issues such as checks, cupping, crowning, warping, buckling, peeling, twisting, seam swelling or gapping. In addition, moisture intrusions from concrete hydrostatic pressure, flooding, or plumbing leaks, along with high levels of alkalinity, can affect flooring and subflooring over time and moisture can be trapped below the flooring and/or underlayment and create mildew or mold. Damage from such conditions, including to the floor and subfloor, is not covered under this limited warranty.
- *Site and Environmental Conditions.* Defects or damages resulting from: site conditions (such as extreme heat, radiant heat (for some products), or exposure to sand); indentations and scratches (caused by furniture, heavy rolling loads like un-modified wheels on caster chairs, castor chairs without protection mats, heavy electric wheel chairs, metal or thin wheels on appliances, tools, grit, heels, pets nails and claws, toys, etc.); improper maintenance and accidents; misuse and abuse. These items are not covered under this limited warranty.
- *Within Waste Factor.* Defects in flooring that do not exceed the Waste Factor (defined above) are not covered under this limited warranty. Consequently, it is recommended that you add the applicable percentage to your total square footage when ordering your floor.

- *Other Finishes.* This limited warranty covers the factory-applied finish only. Applying another finish or sanding (such as in preparation for another finish) may damage the factory-applied finish and voids this limited warranty against finish wear.
- *Exterior/Outdoor Installations/Use.* This limited warranty does not cover exterior, outdoor, partial outdoor installations / use of the product.
- *Non-Flooring Installations.* Except where the product's Installation and Care Requirements designate the product as appropriate for wall installation, this limited warranty does not cover use of the products for installations on ceilings or other usages for purposes other than flooring (like furniture or countertops).
- *Visible Defects.* As discussed further below in Section 5.C., products installed with visible defects are not covered under this limited warranty. Accordingly, before installation, you and the installer should examine each product to ensure it is satisfactory.
- *Natural Characteristics.* Wood and bamboo are natural products. They may change as a result of the conditions to which they are exposed including seasonal and environmental factors. Color changes due to aging or exposure to UV/sunlight may also occur. In addition, natural variations from board to board, like differences in grain, color, tone, and knots, may exist.
- *Expansion and Contraction.* As a product of nature, wood and bamboo react to changes in temperature and humidity. Small gaps between planks are a normal occurrence with changes in relative humidity. These gaps are seasonal and show up primarily in the winter when cold temperatures lower the relative humidity in the air. Engineered wood and bamboo flooring perform best at relative humidity ranges between 30% and 70% and temperatures between 60°F and 80°F (not to exceed a 30% fluctuation in relative humidity), before, during and after the installation and remain at such levels throughout the life of your floor to ensure optimum performance. Please note that ideal interior environmental conditions will vary from region to region and jobsite to jobsite, the relative humidity figures on your project maybe higher or lower. You must ensure that the change in relative humidity stays within a 30% range (e.g., 30% to 60%) and does not fluctuate beyond 30% for sustained periods, which may affect the flooring. Home environments where the relative humidity drops below 30% are not recommended or subject to coverage under this limited warranty. Seasonal homes or leaving a building/structure unoccupied without climate control for extended periods of time can lead to damage to the floor from excessive humidity build-up or extremely dry conditions. Both scenarios can damage the floor, cabinets, and furniture.
- *Color and Shade Variations.* New or replacement flooring may not always match samples, printed color photography (including websites and catalogs), existing flooring or other products (such as cabinets, stair railings, trim and moldings) due to, among other things, natural variations that occur in species, age, growing conditions, exposure to UV/sunlight and other factors. These variations should be expected. Inspect product before installation. Claims for color and shade variation will not be accepted after the product is installed.

- *Discoloration/Fading from Mats.* This limited warranty does not cover discoloration due to use of rubber-backed mats or other incompatible mats.
- *Odd Lots or As-Is.* An odd lot is flooring that is discounted and sold “As-Is” because it did not pass our rigorous inspection process. As such, odd lot product is not covered by this limited warranty.
- *Third-Party Purchases.* This limited warranty does not cover any purchases other than those made directly from LL Flooring in store, online, or by phone.
- *Radiant Heat.* Please consult the Installation and Care Requirements regarding whether your product may be installed over radiant heat. If your Installation and Care Requirements do not include materials regarding installation over radiant heat, your product is not appropriate for installation over radiant heat and not covered under this limited warranty for such installations. If your Installation and Care Requirements provide instructions for such installation, this limited warranty does not cover those products that are not installed according to the radiant heat manufacturer guidelines or not installed in compliance with the Installation and Care Requirements.
- *Removal and Replacement.* This limited warranty does not cover the cost of the removal or replacement of countertops, cabinets, built-in appliances, or other fixtures, installed on top of your floor.
- *Improper Installation and Maintenance.* This limited warranty does not cover any dissatisfaction or damage due to improper installation or maintenance. This includes any damages caused by any installation (regardless of the source of the installation advice) that conflicts with the applicable industry installation standards and product installation instructions—for example, damage caused by sub-surface, sub-flooring and jobsite environmental deficiencies, improper transportation, acclimation, and storage.

5. HOW DO I MAINTAIN THIS LIMITED WARRANTY DURING THE LIMITED WARRANTY PERIOD?

To maintain this limited warranty during the Limited Warranty Period, you are obligated to meet all of the following requirements for your use, installation, and maintenance of the product (the “Installation and Care Requirements”). The Installation and Care Requirements must be strictly followed for the limited warranty to remain valid and not be void.

- A. *Follow the Pre-Installation Requirements.* Prior to installing a single board, tile, or product, you or the installer must determine that the job-site environment and the sub-surfaces (including subfloor substrates) meet or exceed applicable industry and product standards, including, without limitation, moisture testing and controls. The product installation instructions discuss these standards and are provided in full below. These requirements must be strictly followed.

- B. *Comply with All Laws.* In your installation, maintenance, and use of the product you must comply with all laws and regulations, including, without limitation, all applicable environmental and building codes, regulations, and laws.
- C. *Inspect All Products for Visible Defects.* Products installed with visible defects are not covered under this limited warranty. Accordingly, before installation, you and the installer should examine each product to ensure it is satisfactory. If any products are unacceptable for any reason, it is up to you to determine to use them, trim off the imperfection, or not install them at all. You should plan on being present during your installation to ensure that all required procedures are completed and products with visible defects are not installed. It is important to inspect individual boards and tiles and to frequently step back to observe the “whole picture” before installation is completed. *If quality issues are suspected before or during installation immediately contact the store where your floor was purchased or call us at 1-800-366-4204.*
- D. *Follow the Installation and Care Instructions.* It is your duty to make sure the installation requirements are strictly followed, including, without limitation, as they relate to the use of moisture barriers, installation tools such as nailers and trowels, and the evaluation of job site conditions and moisture testing. The product’s installation and care manual(s) are provided in this document below, and those terms and provisions are part of this limited warranty.

6. WHAT ARE YOUR REMEDIES UNDER THIS LIMITED WARRANTY?

With respect to any defective product during the Limited Warranty Period, we will provide a LL Flooring store credit in the amount of the purchase price paid for the defective portion of the flooring (excluding any installation costs and labor) in excess of the applicable Waste Factor (defined above). A store credit is the sole remedy under this limited warranty and can be used for store product purchases only. Provided, however, we reserve the right, in our sole discretion, to repair or replace such product (or the defective part) free of charge in lieu of a store credit. We will also pay for shipping and handling fees to return the repaired or replacement product to you if we elect to repair or replace the defective product.

This limited warranty applies to the colors, designs and products available at the time of repair or replacement. If the original flooring is not available, LL Flooring will work with you to substitute a product of similar value. LL Flooring will always try to consider your needs.

We reserve the right to investigate, assess, and validate reported claims by, among other things, requesting samples from you for technical analysis and your reasonable cooperation to permit us to perform an inspection of the flooring and installation location.

7. HOW DO YOU OBTAIN WARRANTY SERVICE?

To file a warranty claim during the Limited Warranty Period, you may:

- A. Visit the store where you purchased your floor;
- B. Call us at 1-800-366-4204; or
- C. Email via the “contact us” link at www.llflooring.com.

Claims must be submitted within the Limited Warranty Period and within ninety (90) days of the date that the problem with the floor is first discovered. No warranty claim will be serviced without contacting us through one of the methods listed above and any such claim must include you providing accurate and complete information in a timely manner.

8. WHAT ARE THE LIMITATIONS OF LIABILITY?

THE REMEDIES DESCRIBED ABOVE IN SECTION 6 ARE YOUR SOLE AND EXCLUSIVE REMEDIES AND OUR ENTIRE LIABILITY FOR ANY BREACH OF THIS LIMITED WARRANTY. NOTWITHSTANDING ANY OTHER PROVISION OR TERM, OF THIS LIMITED WARRANTY, OUR LIABILITY SHALL UNDER NO CIRCUMSTANCES EXCEED THE ACTUAL AMOUNT PAID BY YOU FOR THE DEFECTIVE PRODUCT OR DEFECTIVE PORTION THEREOF.

UNDER NO CIRCUMSTANCES SHALL WE BE LIABLE FOR ANY CONSEQUENTIAL, INCIDENTAL, SPECIAL OR PUNITIVE DAMAGES OR LOSSES, WHETHER DIRECT OR INDIRECT. WITHOUT LIMITING THE FORGOING SENTENCE, LOSSES, DAMAGES OR EXPENSES RELATING TO ANYTHING OTHER THAN THE FLOOR ITSELF ARE NOT COVERED, INCLUDING, WITHOUT LIMITATION, MISSED TIME FROM WORK, HOTEL STAYS, STORAGE FEES, KENNEL COSTS FOR PETS, REMOVAL OF DEFECTIVE FLOORING, INSTALLATION OF REPLACEMENT FLOORING, OR REMOVAL OR REPLACEMENT OF ITEMS BUILT ON TOP OF ANY FLOORING (FOR EXAMPLE, COUNTERTOPS, CABINETS, BUILT-IN APPLIANCES).

SOME STATES AND JURISDICTIONS DO NOT ALLOW THE EXCLUSION OR LIMITATION OF INCIDENTAL OR CONSEQUENTIAL DAMAGES, SO THE ABOVE LIMITATION OR EXCLUSION MAY NOT APPLY TO YOU.

9. TERMS OF DISPUTE RESOLUTION

NO JOINT OR CLASS ACTIONS: Neither you nor LL Flooring shall be entitled to join or consolidate claims in arbitration by or against other customers of LL Flooring with respect to other accounts, bring mass, class action, or consolidated claims in arbitration or a court of competent jurisdiction, or arbitrate or litigate any claim as a representative or individual of a class or in a private attorney general capacity. The arbitrator may not consolidate more than one person’s claims and may not otherwise preside over any form of a representative or class proceeding.

ARBITRATION: The following informal dispute resolution procedure is available to you if you believe that we have not performed our obligations under this limited warranty. You must use this informal procedure before pursuing any legal remedy in the courts.

LL Flooring and you agree to attempt to resolve any disputes amicably. If, after thirty (30) days we are unable to do so, then you and LL Flooring each agree that any claim or controversy of any sort relating to our agreement, the Products or these limited warranty terms shall be determined by arbitration in the nearest U.S. city to the LL Flooring store where you purchased the products, before one arbitrator. At the option of the first to commence an arbitration, the arbitration shall be administered either by JAMS pursuant to its Streamlined Arbitration Rules and Procedures, or by the American Arbitration Association pursuant to its Commercial Arbitration Rules. The arbitrator shall have no power to add to, delete from or modify these limited warranty terms. Each of us shall have the right to conduct discovery to which we would be entitled had the dispute been resolved in a state court of general jurisdiction in the state of the LL Flooring store where you purchased the products. Judgment on the arbitrator's award may be entered in any court having jurisdiction. This clause shall not preclude either party from seeking provisional remedies in aid of arbitration from a court of appropriate jurisdiction. The arbitrator may, as part of the award, allocate all or part of the costs of the arbitration, including the fees of the arbitrator and the reasonable attorneys' fees of the prevailing party. The arbitrator shall only have the authority to resolve individual disputes between you and LL Flooring. Notwithstanding the foregoing, in addition to our rights set forth above, we may initiate proceedings directly in the appropriate court located in the U.S. city nearest the LL Flooring store where you purchased the products in connection with any claim to collect amounts due and owing by you.

10. NO OTHER TERMS

SAMPLES, DESCRIPTIONS, AND OTHER INFORMATION CONCERNING THE PRODUCT CONTAINED IN CATALOGS, ADVERTISEMENTS, OR OTHER PROMOTIONAL MATERIAL OR STATEMENTS MADE BY SALES REPRESENTATIVES OR DISTRIBUTORS ARE FOR GENERAL INFORMATIONAL PURPOSES ONLY AND ARE NOT BINDING UPON LL FLOORING. NO SALES REPRESENTATIVES, STORE MANAGERS, ACCOUNT REPRESENTATIVES, OR DISTRIBUTORS SHALL HAVE ANY AUTHORITY WHATSOEVER TO ESTABLISH, EXPAND OR OTHERWISE MODIFY LL FLOORING WARRANTIES. THE TERMS OF THIS LIMITED WARRANTY DOCUMENT MAY NOT BE AMENDED EXCEPT THROUGH A WRITTEN AGREEMENT TITLED "AMENDMENT TO LIMITED WARRANTY" AND SIGNED BY AN AUTHORIZED OFFICER OF LL FLOORING, PROVIDED, HOWEVER, THAT LL FLOORING MAY GENERALLY MODIFY, CANCEL, UPDATE, OR OTHERWISE CHANGE ITS PROSPECTIVE WARRANTIES FOR FUTURE SALES AT ANY TIME AND FOR ANY REASON.

11. OTHER PROVISIONS

The section headings provided in this limited warranty are for convenience and informational reference only and shall not affect the interpretation or construction of this limited warranty.

THE PROVISIONS OF THIS LIMITED WARRANTY ARE DEEMED TO BE SEVERABLE AND THE INVALIDITY OR UNENFORCEABILITY OF ONE PROVISION SHALL NOT AFFECT THE VALIDITY OR ENFORCEABILITY OF ANY OTHER PROVISION.



12. ADDRESS FOR LL FLOORING

LL Flooring, Inc. is located at 4901 Bakers Mill Lane, Richmond, VA 23230.

[HOME * INSTALLATION * CARE](#)

Nail Down/ Nail Glue Assist * [Glue Down Method Click Here](#) * [Edge Glue Float Method Click Here](#) * [Wall Application Click Here](#)

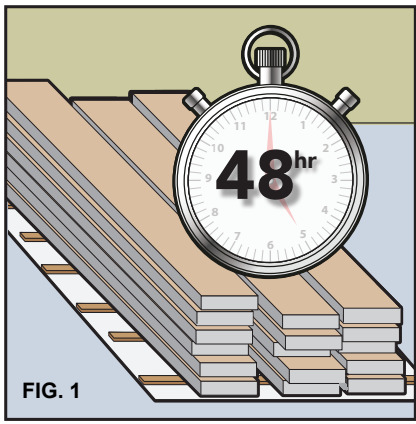
Save time & avoid frustration! Please read these entire instructions before starting your installation, and A.I.M. for success!

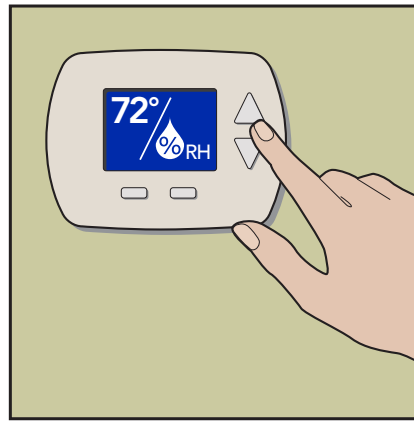
AIM	AIM	AIM
 <p>FIG. 1</p>		
<p>Acclimate Completely Acclimate your flooring to your home environment. Time for acclimation will vary. Always check using a meter. Acclimation will ensure your flooring looks great for years to come</p>	<p>Install Correctly Take time to review LL Flooring’s installation guidelines and follow the National Wood Flooring Association Guidelines to ensure that your installation goes well from beginning to end.</p>	<p>Maintain Environment The ideal Relative Humidity (RH) range for Hardwood is 30%–50% at a temperature of 60°–80°F. It is acceptable in some households that this range may be higher or lower, but extreme fluctuations in RH must be avoided*.</p>

*See Temperature and Relative Humidity for more details.



Need Help? To obtain installation assistance or product information concerning this flooring, contact the store of original purchase, or call the LL Flooring’s customer care at 800-366-4204.



WARNING! DO NOT SAND, DRY SWEEP, DRY SCRAPE, DRILL, SAW, BEADBLAST OR MECHANICALLY CHIP OR PULVERIZE EXISTING RESILIENT FLOORING, BACKING, LINING FELT, ASPHALTIC “CUTBACK” ADHESIVES OR OTHER ADHESIVES. These products may contain asbestos fibers and/or crystalline silica. Avoid creating dust. Inhalation of such dust is a cancer and respiratory tract hazard. Smoking by individuals exposed to asbestos fibers greatly increases the risk of serious bodily harm. Unless positively certain that the product to be removed is a non-asbestos containing material, you must presume it contains asbestos. Regulations may require that the material be tested to determine asbestos content. See current edition of the Resilient Floor Covering Institute (RFCI) publication, “Recommended Work Practices for Removal of Resilient Floor Coverings” for detailed information and instructions on removing all resilient covering structures. For current information, go to www.rfci.com.



LEAD WARNING: Some paints and finishes in homes built before 1978 may contain lead. Exposure to excessive amounts of lead dust presents a health hazard. Prior to removing or sanding, comply with all applicable federal, state, and local laws, and reference the publication “Lead-Based Paint: Guidelines for Hazard Identification and Abatement in Public and Indian Housing” available from the United States Department of Housing and Urban Development regarding (1) appropriate methods for identifying lead-based paint and removing such paint; and (2) any licensing, certification, and training requirements for persons performing lead abatement work.



MOLD AND MILDEW WARNING: Prior to removing an existing resilient floor or when installing a new floor, if there are visible indications of mold or mildew or the presence of a strong musty odor in the installation area, the source of the problem should be identified and corrected before proceeding with the flooring work. Excessive moisture in the subfloor could promote mold, mildew, and other moisture related issues like the trapping of moisture emissions under the flooring, which may contribute to an unhealthy indoor environment. Mold has the potential to cause health problems and may produce allergens, irritants, and in some cases, potentially toxic substances. Before installing the new resilient flooring, ensure the underlayment and/or subfloor is allowed to thoroughly dry and that any residual effect of excessive moisture, mold, or structural damage has been corrected. Remediation measures may require structural repairs such as replacing the contaminated underlayment and/or subfloor, cleanup measures using appropriate protection and biocide, or hiring a professional mold and mildew remediation contractor. Consult EPA mold guidelines on EPA’s website at <https://www.epa.gov/mold>



WARNING: Drilling, sawing, sanding or machining wood products can expose you to wood dust, a substance known to the State of California to cause cancer. Avoid inhaling wood dust or use a dust mask or other safeguards for personal protection. For more information go to www.P65Warnings.ca.gov/wood

RECOMMENDED USE:

- Residential or light commercial* interior use only. *See the product's limited warranty for details.
- **Do not install in wet areas like patios and showers, or exterior areas. Do not install in boats, moving vehicles or over radiant heat.**

Grade: On, above and below Grade.

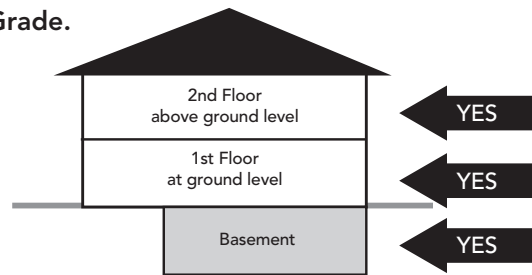

JOBSITE CONDITIONS:

- The building should be enclosed with all doors and windows in place.
- **Prior to delivery and install:** All wet works (e.g. drywall taping, texture, painting, stucco etc.) should be complete and allowed to dry. The rooms should be at normal "lived-in" conditions with HVAC operational for at least one week prior to the installation when home is so equipped.
- When installing in rooms over basements and garages, ensure they are dry and well ventilated.
- Crawlspace must be dry with a minimum 18" from the bottom of the floor joist to the ground, Crawl space earth (or thin concrete slab) should be covered 100 percent by a vapor retarder of black polyethylene (minimum 6 mil) or any recommended puncture-resistant membrane, such as Class C, meeting ASTM D1745. Ventilation shall be per local building codes.
- To avoid damages to the floor's finish, all construction activity should be completed before installing this floor.
- All gutters should be in place and functioning properly. Yard grading should be sloped to run water away from the home foundation.
- The installer - not the manufacturer or retailer - is responsible for making sure that the site conditions are appropriate prior to installation of this floor.

ACCLIMATION: 48 Hours

- Stack boxes no more than eight cartons high in areas to receive new flooring (remove plastic from outside of boxes if present).
- Ensure each layer is evenly supported to prevent distortion. Elevate stack using 2 x 4's.
- **On concrete; place a layer of 6 mil poly down first during the acclimation process.**
- Extended acclimation time should be anticipated and may be required. Time is not the determining factor; moisture testing is required to confirm that product is acclimated. Use a meter that is species adjustable, E.g. Ligno-scanner SDM or mini-Ligno DX/C moisture meter. If using alternate meter check with manufacturer that meter can be used with the wood species that you are installing.
- Check the moisture content of multiple planks. It's recommended to randomly test 40 planks for every 1000 square feet of flooring, the flooring's average moisture content must be within 4% of the subfloor.
- Keep a permanent record of all readings.

TEMPERATURE:

For best product performance, ensure the temperature in the home is between 60° and 80° F before, during, and after installation and for the life of the flooring.

RELATIVE HUMIDITY:

For best performance, flooring should be ideally conditioned, installed and maintained to consistent indoor temperatures of 60°- 80°F and relative humidity of 30% - 70% (not to exceed a 30% fluctuation in relative humidity, before, during and after the installation and for the life of the flooring. Ideal interior environmental conditions will vary from region to region and jobsite to jobsite, the relative humidity figures on your project maybe higher or lower.

The key is to ensure that the change in relative humidity stays within a 30% range (e.g.30% to 60% or 35% to 65% etc...) and does not fluctuate beyond 30% for sustained periods, enough to affect the flooring. Home environments where the relative humidity drops below 30% or exceed 70% are not recommended.

Not following the written recommendations can negatively impact board performance and may result in excessive movement, squeaks, board gapping, board-edge cupping, cracks, twists, finish splits, flaking, chipping, fading and other related issues.

Any home that may have a sustained change in relative humidity greater than 30% fluctuation needs an HVAC system equipped with a humidifier or dehumidifier to regulate the interior environment within a 30% range of fluctuation. Installing hardwood in an environment that is not maintained can be detrimental to the flooring.

The map below can be used to calculate what the optimum baseline or average moisture content of interior wood products should be prior to installation for each state and region. The first number indicates the average moisture content of wood during the wintertime (months having lower humidity), and the second number indicates the average moisture content during the summer time or (months having higher humidity).

To calculate the optimal baseline or average wood moisture content in your state or region, add the high season number and low season number together then divide by two. Example: If your state or region has an expected low of 6% to a high of 12% moisture content, the average baseline moisture content of the wood before installation would be 9%. The goal is to acclimate the flooring to this average figure and then the installation can begin.

Very dry or humid regions of the country usually require extended conditioning to balance the new flooring to the environment it will service.

Summer / Winter Moisture Map

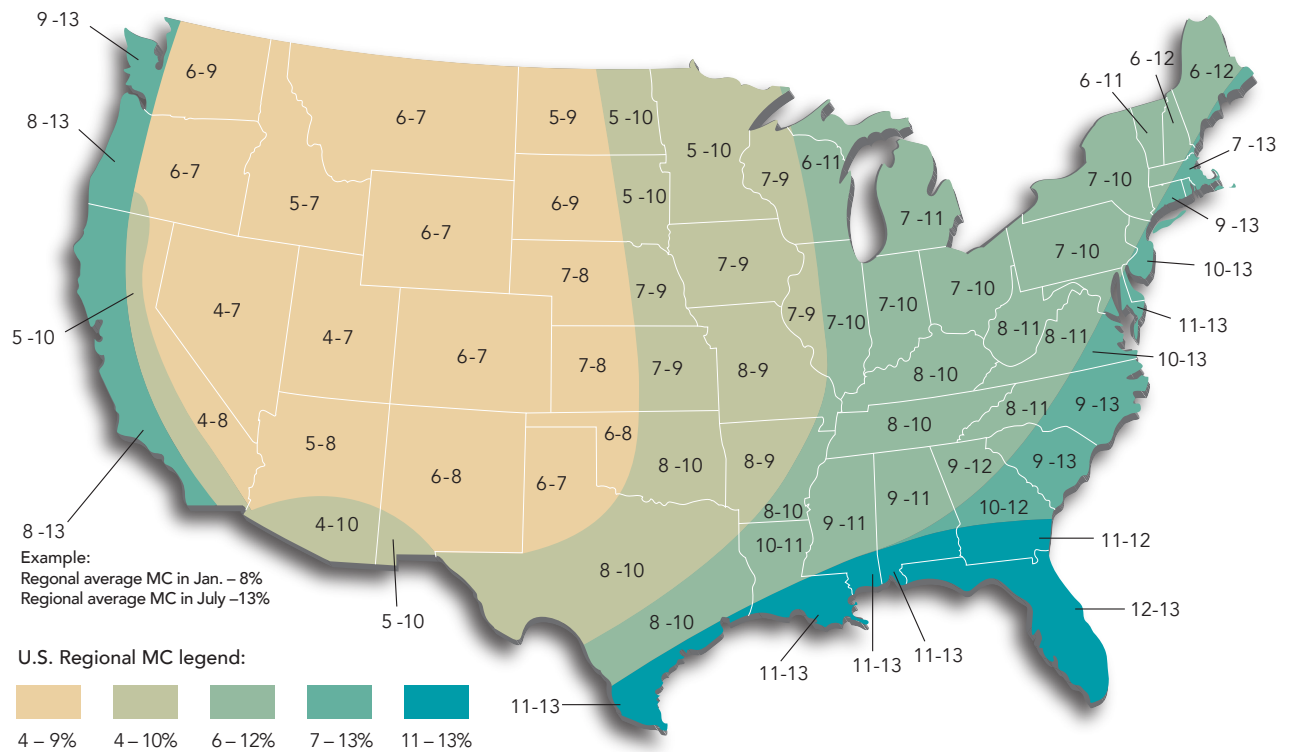

The effects of Temperatures and Humidity on wood flooring

Wood products are sensitive to moisture, temperature and humidity. Refer to the chart below to better understand the best in-home environmental relationship between relative humidity (RH) and temperature and its effects on wood moisture content. Determine the current temperature and RH within your home with a hygrometer. Find the combination of temperature and RH in your area on the chart (temperature variations are listed on the left side of the chart, humidity variations are listed along the bottom).

Example: The target or ideal moisture content for wood products is shown in the shaded area to be within 6.1% to 9.4%. Wood flooring will perform best when the interior environment is controlled to stay within a relative humidity range of 30% to 50% and a temperature range of 60° to 80° Fahrenheit. (In some geographical areas, the ideal humidity range might be higher or lower, 30% to 60% or 35% to 65% for example.) It is critical to maintain the relative humidity in your home to not fluctuate more than 30% at any given time of the year. Eng' Hardwood flooring installed in areas with a wider variation in RH (fluctuation in RH of more than 30%) can negatively impact board performance and may result in excessive movement (expansion / contraction, squeaks, board gapping, board-edge cupping, finish splits and other related issues).

Moisture Content of Wood at Various Temperatures and Relative Humidity Readings

°F	5	10	15	20	25	30	35	40	45	50	55	60	65	70	75	80	85	90	95	98
30	1.4	2.6	3.7	4.6	5.5	6.3	7.1	7.9	8.7	9.5	10.4	11.3	12.4	13.5	14.9	16.5	18.5	21.0	24.3	26.0
40	1.4	2.6	3.7	4.6	5.5	6.3	7.1	7.9	8.7	9.5	10.4	11.3	12.4	13.5	14.9	16.5	18.5	21.0	24.3	26.0
50	1.4	2.6	3.7	4.6	5.5	6.3	7.1	7.9	8.7	9.5	10.4	11.3	12.4	13.5	14.9	16.5	18.5	21.0	24.3	26.0
60	1.3	2.5	3.6	4.6	5.4	6.2	7.0	7.8	8.6	9.4	10.2	11.1	12.1	13.3	14.6	16.2	18.2	21.7	24.1	26.8
70	1.3	2.5	3.6	4.5	5.4	6.2	6.0	7.7	8.5	9.2	10.1	11.0	12.0	13.1	14.4	16.0	17.9	20.5	23.9	26.6
80	1.3	2.4	3.5	4.4	5.3	6.1	6.8	7.6	8.3	9.1	9.9	10.8	11.7	12.0	14.2	15.7	17.7	20.2	23.6	26.3
90	1.2	2.3	3.4	4.3	5.1	5.9	6.7	7.4	8.1	8.9	9.7	10.5	11.5	12.6	13.9	15.4	17.3	19.8	23.3	26.0
100	1.2	2.3	3.3	4.2	5.0	5.8	6.5	7.2	7.9	8.7	9.5	10.3	11.2	12.3	13.6	15.1	17.0	19.5	22.9	25.6

Chart taken from Wood Handbook: Wood as an engineering Material (Agriculture Handbook, 72).
Forest Products Laboratory, U.S. Department of Agriculture

CUTTING ALLOWANCE and MANUFACTURER TOLERANCE (waste factor):

A 10' x 10' room has net 100 square feet (Sq. Ft.) – the actual area that will have flooring – but more product is required to allow for cutting which generates unusable pieces.

Carefully measure the net square feet required, adding up multiple areas.

The table gives an approximate recommendation for cutting allowance:

Quantities are always rounded up to the nearest box.

Note: Engineered Natural products generally have a 5% manufacturer tolerance which should be added to the Cutting allowance.

If defects are greater than the waste factor indicated for your flooring, please contact your local store or call Customer Care at 1-800-366-4204.

Tip: If more than half a box is not available for spares we recommend ordering an extra box.

Please note: Actual cutting waste may be lower or higher based on room layout. E.g. multiple rooms vs. one large area and "pattern" being installed.

Consider carefully before returning boxes. Keeping extra boxes is a great idea and inexpensive insurance against damage if a repair is needed. The product and batch will be the same, and you have options even if the product has been discontinued.

Diagonal installations may require 5% extra material over and above the cutting and manufacturer tolerance allowance.

Net Area SqFt	Total with Cutting Allowance SqFt	% Applied
100	110	10
200	218	9
400	432	8
600	642	7
800	848	6
1000	1050	5
above 1000 SqFt add 5%		

EXPANSION SPACE AND CONTRACTION OVERLAY:

Allow 1/2" gap and 1/2" overlay between the flooring and all vertical obstructions (walls, door jams, pipes, staircases, posts, fixtures, built-ins, etc.) when installed as a "floating" floor. See examples below of 1/2" expansion gap and contraction overlay.

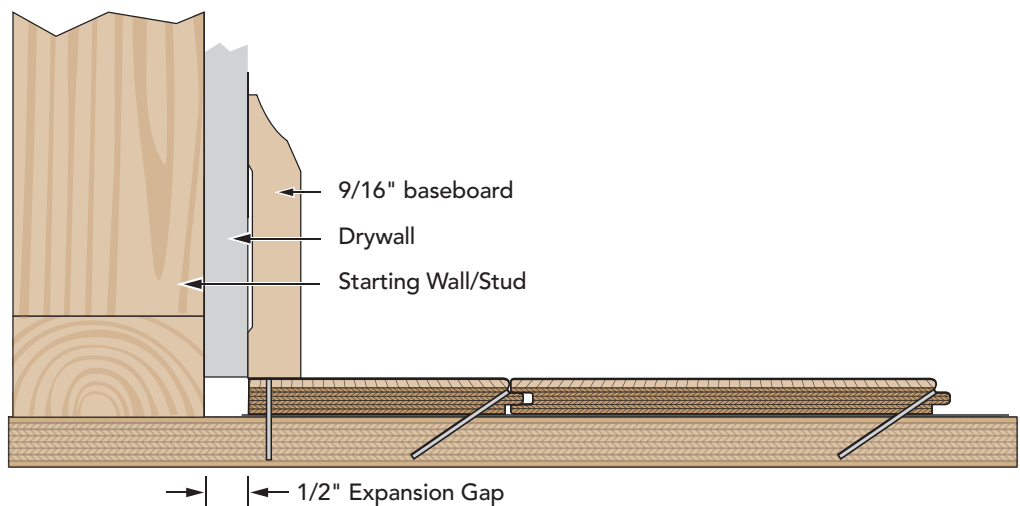
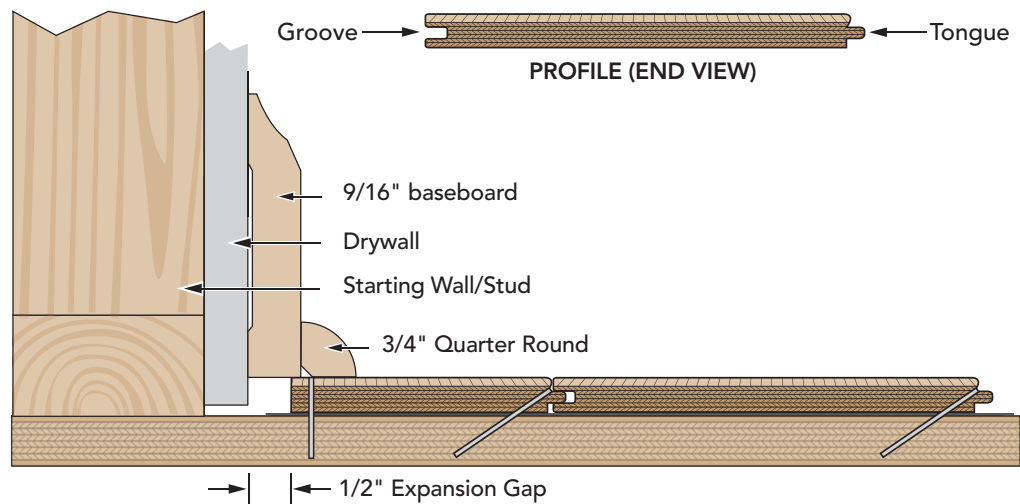

If the room has electric baseboard heaters, leave a minimum of 3/4" between the surface of the flooring and the bottom of the heaters, allowing heat to circulate properly.

NOTE: Gapping and buckling can develop if expansion space and contraction overlay are not followed requirements are not followed.

RUN WIDTH AND LENGTH:

Nail down: No limit in run length or width.
Flooring must have room to expand and contract freely.

CABINETS / FIXED FIXTURES:

Although not recommended, cabinets may be installed on top of this product (See the product's limited warranty for details).

SUNLIGHT:

Depending on the species, your flooring will naturally change color "patina" with prolonged exposure to sunlight. Use of window coverings, shades, or tinting your windows is recommended to slow this natural process.

SUBFLOORS NEED TO BE CLEAN – FLAT – DRY:

Wood substrates must be structurally sound and free from movement or deflection.

CLEAN:

Free from particles including but not limited to: dust, dirt, and grit.

SUBFLOOR MUST BE FLAT AND SMOOTH

FLAT:

Subfloors must be flat within 1/8" over 6' and 3/16" over 10' and smooth, abrupt peaks and valleys must be avoided.

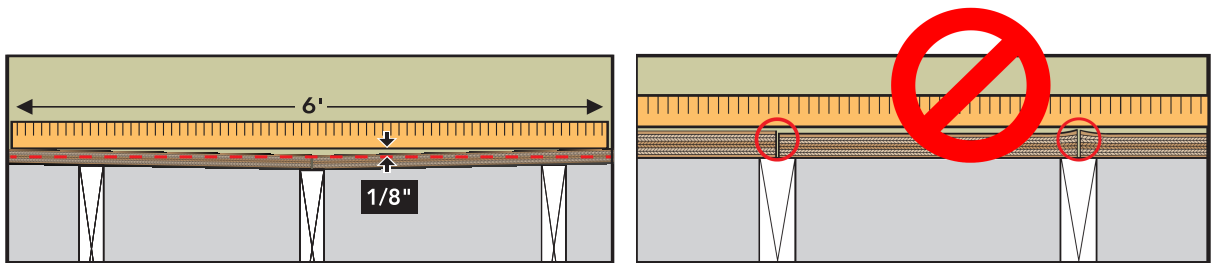

- **Improper substrate or flatness can result in gaps, squeaks, premature wear on surface and poor plank fitting during assembly.**

Correct any issues.

DRY:

See Moisture Testing requirements below.

Do not install this flooring over plywood underlayment attached to concrete, unless it is known that an appropriate moisture barrier has been installed (all applications).

WOOD SUBFLOOR PREPARATION:

- Screw down loose or squeaky sections of plywood and replace areas that are damaged.
- To address flatness concerns sand or plane high spots, 15 - 30 lb. roofing felt can be used to build up (in layers) low areas on wood subfloors.
- Substrates that are un-level due to structural deficiencies should be repaired by a licensed contractor.
- **Never apply plastic sheet over wood subfloors.**

STRUCTURAL REQUIREMENTS:

Note that joist spacing determines minimum subfloor thickness.

Joist spacing 16" on center (OC) or less

– Plywood: Minimum of (5/8", 19/32") Oriented Strand Board (OSB): minimum (3/4", 23/32")

Advantech minimum (3/4", 23/32")

Joist spacing 16" up to 19.2" (OC)

– Plywood: Minimum of (3/4", 23/32") Oriented Strand Board (OSB): minimum of (3/4", 23/32")

Joist spacing over 19.2" up to maximum 24" (OC)

– Plywood: Minimum of (7/8") Oriented Strand Board (OSB): Minimum of (1") or two layers of subflooring or brace between truss/joists in accordance with local building codes.

Particleboard panels are not an acceptable underlayment for nailing down wood flooring, due to their inability to hold fasteners or retain integrity as fasteners are driven in. Where particleboard exists, replacement of the subfloor to NWFA Guidelines, or installation of a double-layer subfloor system is required.

Double layer subfloor system:

The particleboard forms the first layer. Over this 19/32" plywood or OSB panels (underlayment grade) are installed. The panels are oriented perpendicular (8' long edge) to the floor framing and offset 4" minimum from the existing subfloor seams, and ends of the panels offset by at least a joist/truss space. (Note seams should never align) Alternatively, panels may be installed on a diagonal.

Maintaining 1/16" – 1/8" gap around all four side of the panel and 3/4" gaps at any vertical obstructions, E.g. Walls, pipes, etc.. Fasten panels at 12" O.C. along panel edges and 12" O.C. grid in the field.

Fasteners should be ring, screw shank nails, proprietary screws, or equivalent fasteners and should penetrate the entire subfloor panel but not the joists/truss.

Application of an elastomeric wood floor or subfloor adhesive is often necessary in joining the two panels together.

MOISTURE TESTING:

Use a meter that is species / material adjustable. E.g. Ligno-scanner SDM or mini-Ligno DX/C moisture meter.

- **If using alternate meter check that meter can be used with the subfloor material in question.**
Test sub-floor in multiple locations, with an appropriate wood moisture meter, it's recommended to test 20 location per 1000 square feet and average the results. Moisture readings must not exceed 12%.
- Higher readings indicate a moisture concern that needs to be addressed before installation can begin.
- For future reference, documenting and saving the test results is recommended.

PREPARATION FOR NAIL / NAIL GLUE ASSIST over CONCRETE SUBFLOORS:

- In some situations, a nail down installation method maybe preferred as an alternative to direct glue to concrete. In this case a plywood subfloor would need to be installed prior to nailing.

PLYWOOD SUBFLOOR OVER CONCRETE

A Floating Subfloor System over concrete (not attached to the subfloor)

- Concrete should be flat to within 1/8" over 6' or 3/16" over 10'
- Install 6 mil (plastic) poly sheeting completely covering the concrete overlap seams 6" and duct tape.
- Minimum two layers of 1/2" minimum CD Exposure 1 Plywood subfloor panels (CDX) 4' x 8' sheets.
- Square-edged plywood panels should be placed with 1/8" gaps between sheets and a 3/4" minimum expansion space at all vertical obstructions and wall lines.
- Place the first plywood layer with edges parallel to wall, without fastening. Leave 3/4" space between wall and plywood.
- Lay the second layer perpendicular or at 45 degree angle to the first.
- Screw and glue (with urethane or construction adhesive) the second layer to first layer on 12" interior grid pattern (6" on the perimeter). Use fasteners long enough to secure the flooring to the subfloor and not penetrate the (plastic) poly sheeting.

Nail-Down Subfloor System over Concrete (attached to the subfloor)

- Use minimum 3/4" (23/32, 18.3mm) CD Exposure 1 Plywood subfloor panels (CDX), 4' x 8' sheets.
- Concrete compressive strength must equal 3000 psi or better.
- Concrete should be flat to within 1/8" over 6' or 3/16" over 10'.
- Install 6 mil (plastic) poly sheeting completely covering the concrete overlap seams 6" and duct tape.
- **Note:** Fasteners may be powder-driven pins, pneumatic driven nails, or other fasteners suitable for concrete application. Check with fastener manufacturer for specification such as length, drill size, and/or shot load where applicable.
- Stagger panel joints allowing approximately 1/8" expansion space around all panels to prevent edge peaking due to compression caused by panel swell.
- Allow 3/4" minimum expansion space at all vertical obstructions.
- Panels should be mechanically fastened. For powder load or pneumatic pressure information, contact the manufacture.
- Nailing requirements, minimum 32 shots per 4' x 8' panel.
- Areas with higher humidity may require additional fasteners.
- Use 1-1/2" long fasteners when nailing 3/4" flooring to this subfloor.

Glue-Down Subfloor System over Concrete (attached to the subfloor)

- Follow the adhesive manufacturers recommendations for type of adhesive, floor prep, moisture barrier and trowel size
- Concrete compressive strength must equal 3000 psi or better.
- Concrete should be flat to within 1/8" over 6' or 3/16" over 10'.
- Use minimum 3/4" (23/32, 18.3mm) CD Exposure 1 Plywood subfloor panels (CDX), 4' x 8' sheets.
- Cut 4' x 8' sheets into (4) 12" x 8" planks.
- Place 12" x 8' planks into wet adhesive, stagger joints min 12" allow planks to fully bond/cure before wood installation.

UNDERLAYMENT:

- Check LL Flooring's product page for cushion recommendations. At a minimum Silicon Vapor Shield® between the flooring and subfloor to minimize squeaking and when installing over crawl spaces, rooms over basements and garages to provide moisture vapor protection. Install underlayment parallel to the new flooring.

RADIANT HEAT

This flooring is not approved for application over any Radiant heating systems.

USER / OWNER / INSTALLER RESPONSIBILITIES:

Install in good lighting.

- Product installation constitutes acceptance. Visually inspect the product and determine acceptability before installation. Claims will not be accepted regarding visual defects after flooring has been installed. If any planks are unacceptable due to color, finish, milling or any other reason, it is your responsibility to determine to use them, hide them in areas like closets, trim off the imperfection, or not install them at all.
- You should plan on being present during your installation to ensure that all required procedures are completed and boards with visible defects are not installed. It is important to inspect individual boards and to frequently step back to observe the "whole picture" before installation is completed.
- A reasonable amount of installed flooring (up to 25% or 100 sq. ft. whichever is less) is enough to determine acceptance of quality.
- Retain a box label and keep on file with your receipt for future reference.
- If quality issues are suspected stop the installation and call your local store or CUSTOMER CARE at 800-366-4204.

HELPFUL TOOLS: (as needed)

- Tape measure • Pencil • Chalk line • 6' level • Miter saw • Table saw • 60 tooth carbide tip saw blades
- Jamb saw • Eye protection • Ear protection • Niosh dust mask • Knee pads • Gloves • Strap Clamps
- Blue painters tape (2080) • PVA wood glue • Compressor with regulator • Air hose • Floor nailer • Brad / Stapler • Drill • Drill bit set • Hammer • Flat pry bar • Broom • Hygrometer (to monitor in-home humidity) • Species adjustable moisture meter (wood) • Calcium chloride moisture or (RH) Relative Humidity test (concrete) • Approved adhesive remover • Cloth rags • Color putty • Stain markers

ADDITIONAL NOTES:

- When moving furniture and heavy equipment, use luan board, plywood, or other similar covering to protect the floor.

Each project is unique and different. Installation advice or recommendations are given as a courtesy and not intended to take the place of an installer's visual inspection, expertise or informed judgment, the end user / contractor on-site is ultimately responsible for ensuring that selected products are appropriate for local conditions and / or their final use of the product.

ENGINEERED FLOORING NAIL and NAIL GLUE-ASSIST METHOD



**FOR WIDE ENGINEERED PLANKS "5" or more" NAIL GLUE-ASSIST method is recommended
(See important details below on page 21)**

STEP 1. GETTING STARTED:

Remove any existing quarter round, shoe moldings, baseboards and doorway transitions. Remove existing floor covering as required, check floor flatness per details on previous page and address any issues. Check that all doors will swing open with adequate clearance over the new flooring prior to starting any work.

Important: Do not cut metal door frames before first confirming it does not violate local building and fire codes. Any metal doors must be addressed by a specialist to adjust.

Undercut all door casings and jambs with a jamb saw to allow the flooring to slide under the doorjamb. If a baseboard is still in place, extend the undercut about 1" beyond the door frame casing. To find the height to cut the jamb, lay a scrap piece of flooring next to the door frame and lay the saw blade on top. After cut, ensure the floor plus underlayment does not bind, always leave 1/16" clearance under the door jamb / casing for the floor to be able to move freely without vertical restriction. **Check for alarm or other low voltage wiring before cutting.** Ensure that appliances have proper clearance to accommodate the new flooring.

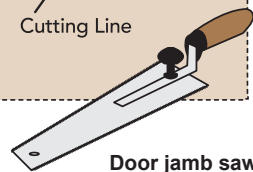
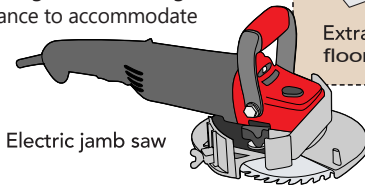
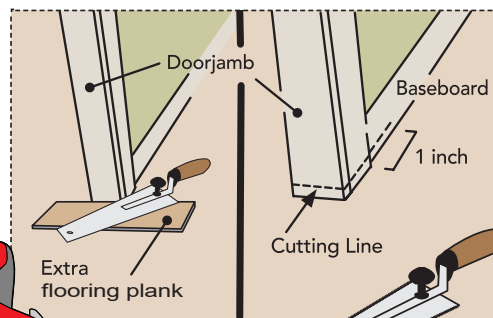

STEP 2. LAYOUT:

Determine which direction the planks will be installed. Install Engineered wood flooring perpendicular or on a diagonal to the flooring joist unless subfloor is modified per NWFA Installation Guidelines. Considerations are fireplaces, doors, cabinets, and transitions. For best appearance, full planks are desirable at the focal point and most cases it is the longest unbroken wall in the room.

Installers: It is advisable to determine the installation layout and direction (North/South vs East/West) with the end user.

Install recommended underlayment as required.

Preparation of planks for the starting row when needed: To avoid very narrow pieces at finish wall, measure the distance between the starting wall to the finish wall, then divide this number by the width of the flooring planks. The fraction is the width of the last plank.

E.g. for a 12' room:

Start – Finish = 144" – 1" (1/2" expansion x 2) = 143"

Width of Plank = 5"

$143 \div 5 = 28.6$

Twenty eight full planks are required and last will be fraction x plank width

$5" \times 0.6 = 3"$

If width of last plank is less than 2.5", balance by cutting (Rip) starting row of planks accordingly.

NOTE: If a narrow strip is unavoidable for the last row, the final two rows can be glued together using PVA tongue and groove adhesive at the long seams to avoid board separation.

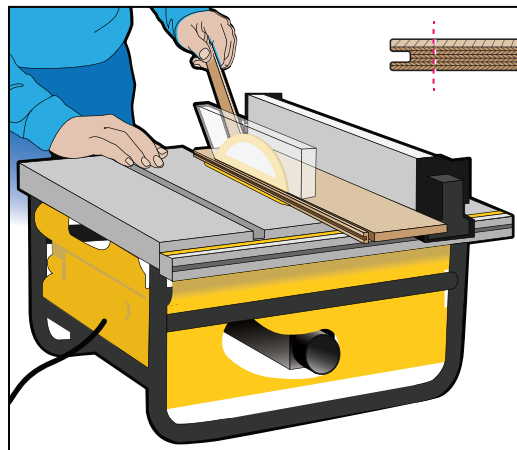

STEP 3. ESTABLISH A WORKING LINE

In at least two places, measure out **equal distance** from your starting wall, 12"–18" from each corner. The distance from the starter wall to the line will be the width of the plank used on first row, the 1/2" expansion space. Mark these points and snap a chalk line (as shown) parallel to your starting wall. Be sure to maintain proper gap around all vertical obstructions, e.g. newel posts, raised hearths, upright pipes, etc. Install the flooring with the tongue side facing away from the starting wall (use long straight planks for the first two rows).

Use wedged spacers to maintain minimum expansion gap between the flooring and the walls. Place spacers adjacent to each plank joint, and at the beginning and end of each row.

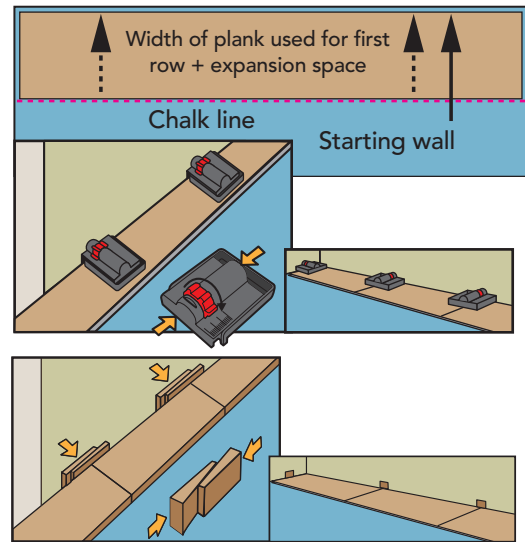

STEP 4. THE FIRST ROW

- Working left to right, lay first plank in the left-hand corner, up against the spacers (the tongue edge should follow along the working line and be facing toward you). Continue laying the first row until you reach the other wall.

Note: See Step 6 for cutting the last plank in row to fit.

- Pre-drill and top nail the first row of boards using a 3/32" drill bit and 6d finishing nails about 1" from the back edge. Countersink the finish nail using a nail punch and fill with close matching wood filler. Confirm the first row is straight. Pre-drill and blind nail the 2nd and 3rd rows using 6d finish nails above the board tongue until nailing machines can be used. (set finish nails with nail punch).

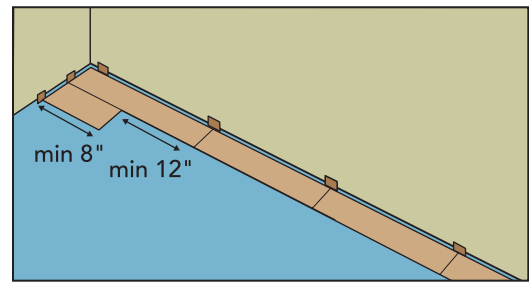

STEP 5. IMPORTANT:

When laying planks, avoid starting or ending rows with cuts (short side) less than 8" in length. Stagger the end joints from row to row, by at least 8" to ensure the structural integrity of your floor and a pleasing appearance.

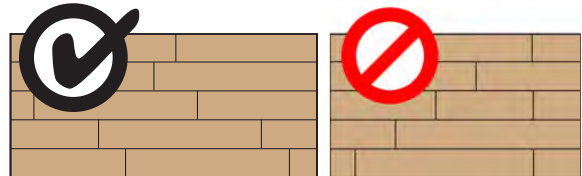

STEP 6. CUTTING END-OF-ROW BOARDS

The last board in each row must be cut to fit, while still maintaining a 1/2" expansion gap at the walls. Here's how:

1. Flip the plank over, end-to-end.
2. Lay the flipped board next to the row of planks and mark it on the face.
3. Cut the plank at the mark
4. Flip the plank back over and install as normal.

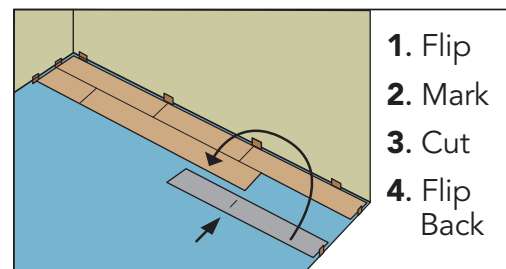

STEP 7. FLOORING (Racking):

After installation of the first three rows, "rack-out" about 100 sq. ft. of flooring approx. 4" or 5" away from the last secured row.

Pull from several boxes to mix board color to create a random look. After racking out 100 sq. ft. of flooring begin nailing the floor, always inspecting the boards for dimpling and defects as you install. Continue nailing until you get to the last one or two rows.

The last one or two rows will have to be top nailed. Again, pre-drill and use finishing nails. The last row will need to be cut lengthwise to fit properly. Allow for proper expansion.

We recommend you use edge glue for this last row if less than 2-1/2" wide.

The best method for cutting this flooring is to use a power miter saw.

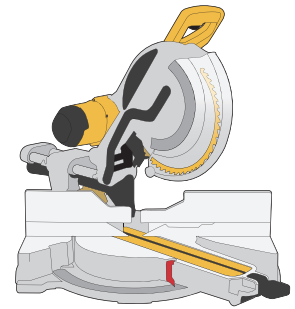

Power table, circular, and jig saws can also be used to cut this flooring product.

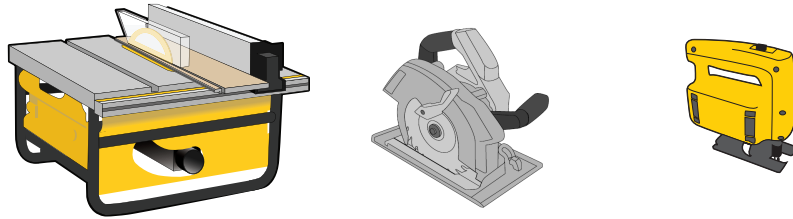

STEP 8. NAIL DOWN:

This engineered wood floor product is typically fastened to a wood subfloor using staples or cleats.

- Only use pneumatic nail guns designed for engineered wood flooring.
- Ensure the use of correct sized fasteners and adaptors. Norge 4 n 1 floor stapler, Stanley Bostich, Powernail, or similar engineered flooring staplers are acceptable
- Test for fastener holding strength to the subfloor by nailing down a few sacrificial boards, check for any damage to planks and then pry up and discard.
- Install moisture retardant underlayment as required.
- Forcing or pounding floor boards together with a rubber mallet during assembly can bruise or damage board edges.
- Check for squeaks after nailing. Squeaks can occur due to tongue fracture, uneven subfloor, improper fasteners, or improper fastener spacing. Squeaks can be corrected or minimized by adding a PVA floating floor wood glue to the tongue and groove of the plank before nailing.
- Do not use significantly bowed, crooked or twisted boards. Use a wood spline or slip tongue whenever a change in board direction is needed. Splines should be glued with PVA wood glue and nailed into place.

Air compressor tips

Adjust the regulator to ensure proper air pressure and setting of fasteners. Set air compressor to 70-80 PSI or at the lowest air pressure needed to set the fastener flush into the wood, adjust as needed, too much pressure can create board-edge damage. Do not exceed the nailer or air hose limitations. Air hose over 25' can cause a poor response, loss of proper PSI, jamming and miss-fire. To prevent air leaks, apply white Teflon tape to all threaded connections. Make sure that the fastening mechanism is recommended for the floor, is in good working condition, is fully adjustable, is at the appropriate angle, and that it seats fasteners properly against the tongue of the board to prevent top edge and surface dimple damage.

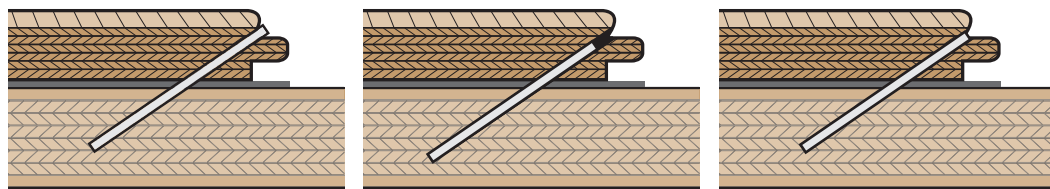

Air Pressure Too Low

Air Pressure Too High

Correct Air Pressure

ENGINEERED WOOD RECOMMENDED FASTENER SELECTION

Board Thickness	Fastener Type	Fastener Length
1/2" — 9/16"	18 or 20 gauge engineered flooring staples or cleats	1-1/4" or 1-1/2" long
3/8"	18 or 20 gauge engineered flooring staples or cleats	1" or 1-1/4" long

Fastener spacing:

Space fasteners at 3"– 4" intervals for staples, 4"– 6" for cleats, and within 1"– 2" of end joints. Use either cleats or staples; do not use both types on the same floor – each holds differently.

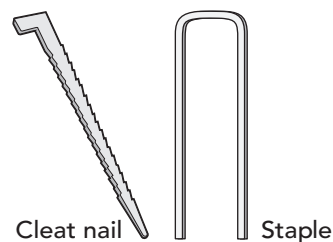

Cleat nail

Staple

NAIL GLUE-ASSIST FOR WIDE ENGINEERED PLANKS "5" OR MORE"

Wider plank flooring uses fewer fasteners per sq. ft. To ensure long-lasting installation fasteners need to be supplemented using adhesive, therefore it is recommended that wide plank (5" or greater) engineered flooring be installed using the nail and glue-assist installation method.

Note: Underlayment is not used for Nail Glue Assist method.

Follow pre-installation guidelines, use the recommended nailing schedule plus an approved wood floor adhesive in cartridge form e.g. Bostik Best or Tread-lock. The adhesive should be applied in a continuous 1/4" bead in a "Serpentine" pattern, a minimum spacing of 1" from the edges and no more than 6" wide (peak-to-peak). When nailing down wood flooring over a conditioned space that is maintained at the same conditions as the living/interior space, no vapor retarder is required. Wood floors installed in these conditions may be nailed with a glue-assist directly to the subfloor.

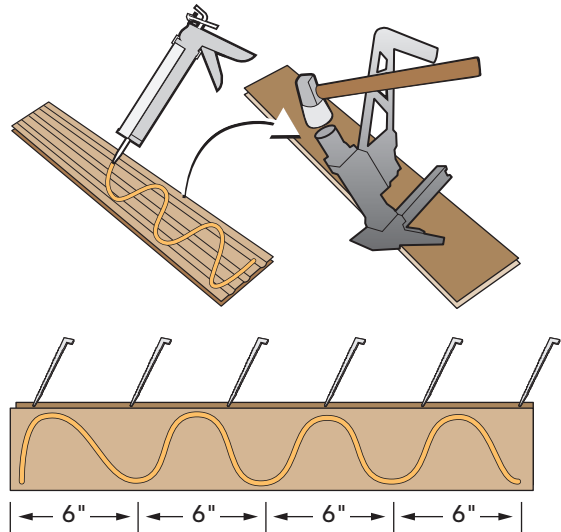

When installing wood flooring over unconditioned space* use of a liquid-applied, or similar Class II vapor retarder that is compatible with the flooring adhesive may be used to allow for a glue-assist directly to the subfloor. E.g. Bostik Roll-Cote.

* not pier or beam and/or where moisture issues are known.

FITTING AROUND IRREGULAR SHAPED OBJECTS:

Make a template to fit around pipes or irregular shaped objects. Place the pattern upon the plank and trace. Cut along the trace lines using a jig saw, and install plank.

Note: Be sure to leave the recommended expansion space around all fixed objects, cabinetry and metal door jambs.

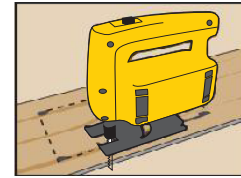

PIPES:

When a pipe is passing through the floor make a hole on the plank 1" greater than the diameter of the pipe, cut the plank with a 45° angle towards the hole. The cut-off piece edges are glued in the position again. *Do not glue to the subfloor.*



When there is single pipe on a wall, you can plan to have the end-joints meet at pipe, drill and install as shown.

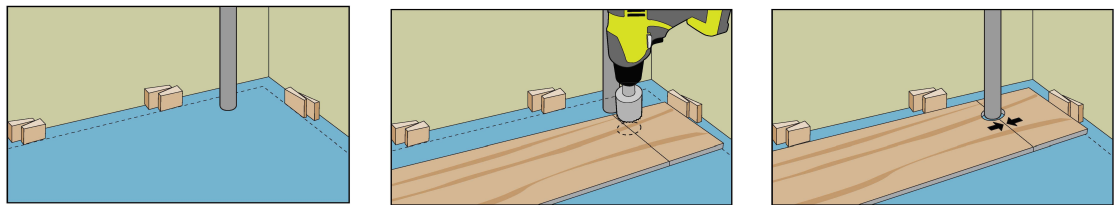

If there are multiple or larger pipes passing through the floor make hole(s) on the plank 1" greater than the diameter of the pipe, cut the plank with a 45° angle towards the hole. The cut-off piece edges are glued in the position again. Do not glue to the subfloor.

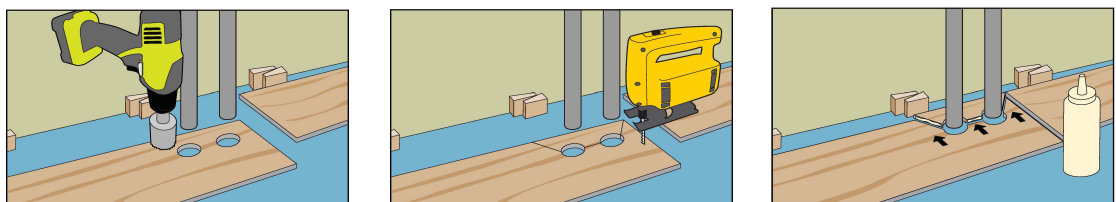

STEP 12.

The last row will need to be cut lengthwise to fit properly. Here's how to get it just right:

- Lay a plank right on top of the last full row in place.
- Then lay another plank of flooring on top of that plank, with the tongue side touching the wall.
- Use plank B as a straight-edge guide, and mark a line lengthwise on plank A.
- Cut plank A lengthwise on line.
- Plank A can now be installed as the last row. We recommend you use edge glue for this last row.

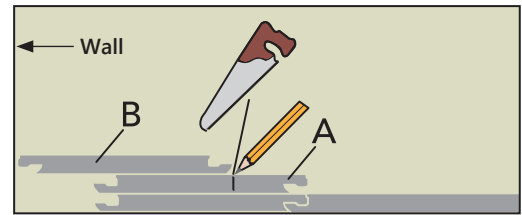

STEP 13.

To ensure the floor is able to “float” freely, be sure to affix baseboards or moldings to the walls, not to the floors. This way, the floor can expand & contract within the gap.

Also, never nail the first or last rows directly down to the subfloor! This option is not appropriate for floating floors!

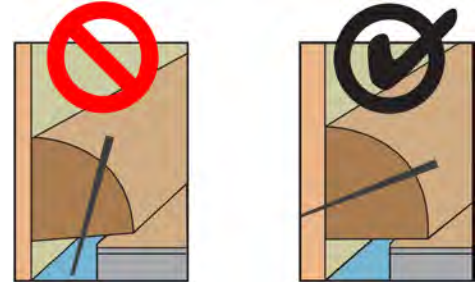

STEP 14. TRANSITIONS:

In areas where your new floor meets other types of flooring, such as carpet or tile, select an appropriate molding to get a professional looking and safe transition.

- Threshold** moldings transition from floor to carpet and are used at sliding doors, raised hearths, etc.
- Overlap Reducer** moldings transition from floors to hard surfaces that are lower than the floor, such as vinyl or VCT tile.
- Overlap Stair nose** moldings must be used for all “floating” installations. E.g.: when the flooring meets at the top of a stairway.”.
- T-Moldings** cover expansion spaces at doorways, and they transition from your new floor to other hard surfaces of similar height.
- 3/4" Quarter Round** moldings are used to cover expansion spaces between the baseboards and the flooring.

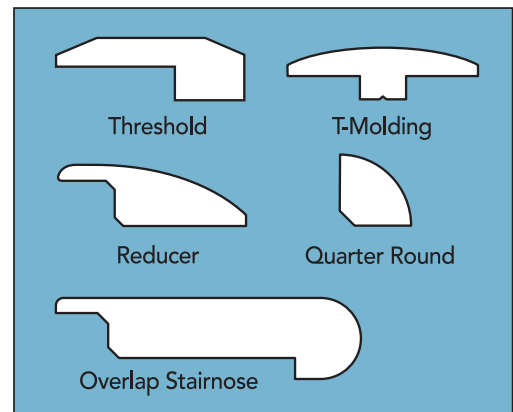

REPAIRS:

Save extra planks from the initial order in the event that installed planks become damaged and repairs are needed. This will ensure lot number and shading compatibility.

[HOME * WARRANTY * CARE](#)



GLUE DOWN *

[Nail Down/Nail Glue-Assist Method Click Here](#) *

[Edge Glue Float Method Click Here](#) *

[Wall Application Click Here](#)

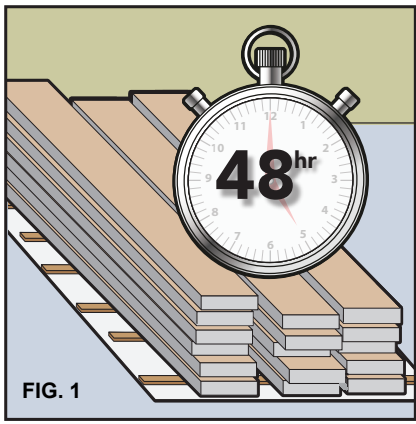
Save time & avoid frustration! Please read these entire instructions before starting your installation, and A.I.M. for success!

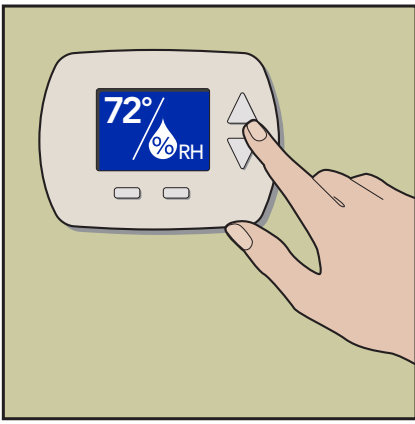
AIM	AIM	AIM
 <p>FIG. 1</p>		
<p>Acclimate Completely Acclimate your flooring to your home environment. Time for acclimation will vary. Always check using a meter. Acclimation will ensure your flooring looks great for years to come</p>	<p>Install Correctly Take time to review LL Flooring's installation guidelines and follow the National Wood Flooring Association Guidelines to ensure that your installation goes well from beginning to end.</p>	<p>Maintain Environment The ideal Relative Humidity (RH) range for Hardwood is 30%–50% at a temperature of 60°–80°F. It is acceptable in some households that this range may be higher or lower, but extreme fluctuations in RH must be avoided*.</p>

*See Temperature and Relative Humidity for more details.



Need Help? To obtain installation assistance or product information concerning this flooring, contact the store of original purchase, or call the LL Flooring's customer care at 800-366-4204.



WARNING! DO NOT SAND, DRY SWEEP, DRY SCRAPE, DRILL, SAW, BEADBLAST OR MECHANICALLY CHIP OR PULVERIZE EXISTING RESILIENT FLOORING, BACKING, LINING FELT, ASPHALTIC "CUTBACK" ADHESIVES OR OTHER ADHESIVES. These products may contain asbestos fibers and/or crystalline silica. Avoid creating dust. Inhalation of such dust is a cancer and respiratory tract hazard. Smoking by individuals exposed to asbestos fibers greatly increases the risk of serious bodily harm. Unless positively certain that the product to be removed is a non-asbestos containing material, you must presume it contains asbestos. Regulations may require that the material be tested to determine asbestos content. See current edition of the Resilient Floor Covering Institute (RFCI) publication, "Recommended Work Practices for Removal of Resilient Floor Coverings" for detailed information and instructions on removing all resilient covering structures. For current information, go to www.rfci.com.



LEAD WARNING: Some paints and finishes in homes built before 1978 may contain lead. Exposure to excessive amounts of lead dust presents a health hazard. Prior to removing or sanding, comply with all applicable federal, state, and local laws, and reference the publication "Lead-Based Paint: Guidelines for Hazard Identification and Abatement in Public and Indian Housing" available from the United States Department of Housing and Urban Development regarding (1) appropriate methods for identifying lead-based paint and removing such paint; and (2) any licensing, certification, and training requirements for persons performing lead abatement work.



MOLD AND MILDEW WARNING: Prior to removing an existing resilient floor or when installing a new floor, if there are visible indications of mold or mildew or the presence of a strong musty odor in the installation area, the source of the problem should be identified and corrected before proceeding with the flooring work. Excessive moisture in the subfloor could promote mold, mildew, and other moisture related issues like the trapping of moisture emissions under the flooring, which may contribute to an unhealthy indoor environment. Mold has the potential to cause health problems and may produce allergens, irritants, and in some cases, potentially toxic substances. Before installing the new resilient flooring, ensure the underlayment and/or subfloor is allowed to thoroughly dry and that any residual effect of excessive moisture, mold, or structural damage has been corrected. Remediation measures may require structural repairs such as replacing the contaminated underlayment and/or subfloor, cleanup measures using appropriate protection and biocide, or hiring a professional mold and mildew remediation contractor. Consult EPA mold guidelines on EPA's website at <https://www.epa.gov/mold>



WARNING: Drilling, sawing, sanding or machining wood products can expose you to wood dust, a substance known to the State of California to cause cancer. Avoid inhaling wood dust or use a dust mask or other safeguards for personal protection. For more information go to www.P65Warnings.ca.gov/wood

RECOMMENDED USE:

- Residential or light commercial* interior use only. *See the product's limited warranty for details.
- **Do not install in wet areas like patios and showers, or exterior areas. Do not install in boats, moving vehicles or over radiant heat.**

GRADE:

On, above and below grade.

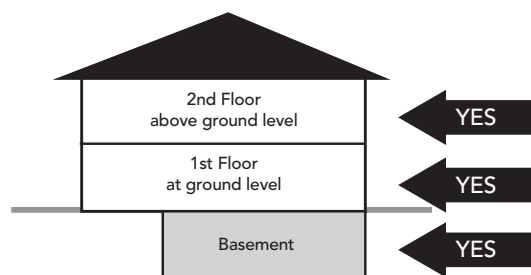

JOBSITE CONDITIONS:

- The building should be enclosed with all doors and windows in place.
- **Prior to delivery and install:** All wet works (e.g. drywall taping, texture, painting, stucco etc.) should be complete and allowed to dry. The rooms should be at normal "lived-in" conditions with HVAC operational for at least one week prior to the installation when home is so equipped.
- When installing in rooms over basements and garages, ensure they are dry and well ventilated.
- Crawlspace must be dry with a minimum 18" from the bottom of the floor joist to the ground, Crawl space earth (or thin concrete slab) should be covered 100 percent by a vapor retarder of black polyethylene (minimum 6 mil) or any recommended puncture-resistant membrane, such as Class C, meeting ASTM D1745. Ventilation shall be per local building codes.
- To avoid damages to the floor's finish, all construction activity should be completed before installing this floor.
- All gutters should be in place and functioning properly. Yard grading should be sloped to run water away from the home foundation.
- The installer - not the manufacturer or retailer - is responsible for making sure that the site conditions are appropriate prior to installation of this floor.

ACCLIMATION: 48 Hours

- Stack boxes no more than eight cartons high in areas to receive new flooring (remove plastic from outside of boxes if present). Ensure each layer is evenly supported to prevent distortion. Elevate stack using 2 x 4's as illustrated in Fig. 1 above.
- **On concrete; place a layer of 6 mil poly down first during the acclimation process.**
- Extended acclimation time should be anticipated and may be required. Time is not the determining factor; moisture testing is required to confirm that product is acclimated. Use a meter that is species adjustable, E.g. Ligno-scanner SDM or mini-Ligno DX/C moisture meter. If using alternate meter check with manufacturer that meter can be used with the wood species that you are installing.
- Check the moisture content of multiple planks. It's recommended to randomly test 40 planks for every 1000 square feet of flooring, the flooring's average moisture content must be within 4% of the subfloor.
- Keep a permanent record of all readings.

TEMPERATURE:

For best product performance, ensure the temperature in the home is between 60° and 80° F before, during, and after installation and for the life of the flooring.

RELATIVE HUMIDITY:

For best performance, flooring should be ideally conditioned, installed and maintained to consistent indoor temperatures of 60°- 80°F and relative humidity of 30% - 70% (not to exceed a 30% fluctuation in relative humidity, before, during and after the installation and for the life of the flooring. Ideal interior environmental conditions will vary from region to region and jobsite to jobsite, the relative humidity figures on your project maybe higher or lower.

The key is to ensure that the change in relative humidity stays within a 30% range (e.g.30% to 60% or 35% to 65% etc...) and does not fluctuate beyond 30% for sustained periods, enough to affect the flooring. Home environments where the relative humidity drops below 30% or exceed 70% are not recommended.

Not following the written recommendations can negatively impact board performance and may result in excessive movement, squeaks, board gapping, board-edge cupping, cracks, twists, finish splits, flaking, chipping, fading and other related issues.

Any home that may have a sustained change in relative humidity greater than 30% fluctuation needs an HVAC system equipped with a humidifier or dehumidifier to regulate the interior environment within a 30% range of fluctuation. Installing hardwood in an environment that is not maintained can be detrimental to the flooring.

The map below can be used to calculate what the optimum baseline or average moisture content of interior wood products should be prior to installation for each state and region. The first number indicates the average moisture content of wood during the wintertime (months having lower humidity), and the second number indicates the average moisture content during the summer time or (months having higher humidity).

To calculate the optimal baseline or average wood moisture content in your state or region, add the high season number and low season number together then divide by two. Example: If your state or region has an expected low of 6% to a high of 12% moisture content, the average baseline moisture content of the wood before installation would be 9%. The goal is to acclimate the flooring to this average figure and then the installation can begin.

Very dry or humid regions of the country usually require extended conditioning to balance the new flooring to the environment it will service.

Summer / Winter Moisture Map

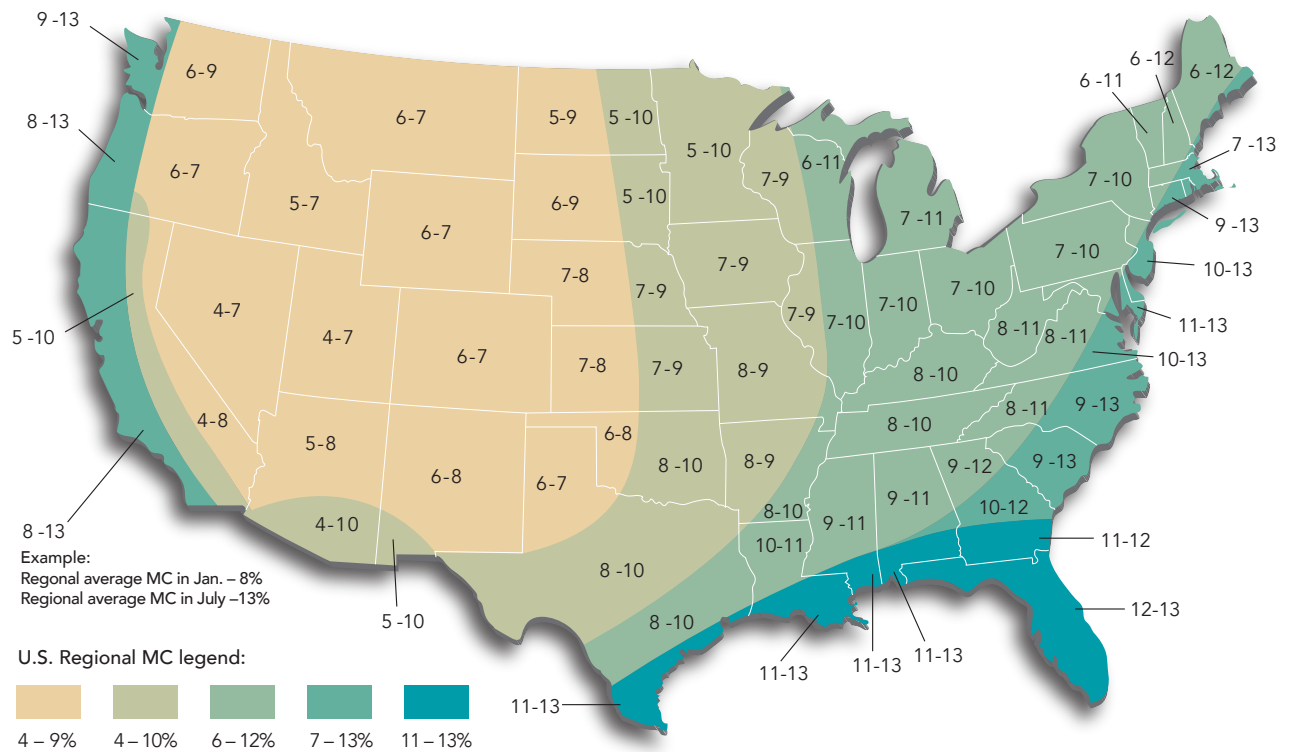

The effects of Temperatures and Humidity on wood flooring

Wood products are sensitive to moisture, temperature and humidity. Refer to the chart below to better understand the best in-home environmental relationship between relative humidity (RH) and temperature and its effects on wood moisture content. Determine the current temperature and RH within your home with a hygrometer. Find the combination of temperature and RH in your area on the chart (temperature variations are listed on the left side of the chart, humidity variations are listed along the bottom).

Example: The target or ideal moisture content for wood products is shown in the shaded area to be within 6.1% to 9.4%. Wood flooring will perform best when the interior environment is controlled to stay within a relative humidity range of 30% to 50% and a temperature range of 60° to 80° Fahrenheit. (In some geographical areas, the ideal humidity range might be higher or lower, 30% to 60% or 35% to 65% for example.) It is critical to maintain the relative humidity in your home to not fluctuate more than 30% at any given time of the year. Eng' Hardwood flooring installed in areas with a wider variation in RH (fluctuation in RH of more than 30%) can negatively impact board performance and may result in excessive movement (expansion / contraction, squeaks, board gapping, board-edge cupping, finish splits and other related issues).

Moisture Content of Wood at Various Temperatures and Relative Humidity Readings

°F	5	10	15	20	25	30	35	40	45	50	55	60	65	70	75	80	85	90	95	98
30	1.4	2.6	3.7	4.6	5.5	6.3	7.1	7.9	8.7	9.5	10.4	11.3	12.4	13.5	14.9	16.5	18.5	21.0	24.3	26.0
40	1.4	2.6	3.7	4.6	5.5	6.3	7.1	7.9	8.7	9.5	10.4	11.3	12.4	13.5	14.9	16.5	18.5	21.0	24.3	26.0
50	1.4	2.6	3.7	4.6	5.5	6.3	7.1	7.9	8.7	9.5	10.4	11.3	12.4	13.5	14.9	16.5	18.5	21.0	24.3	26.0
60	1.3	2.5	3.6	4.6	5.4	6.2	7.0	7.8	8.6	9.4	10.2	11.1	12.1	13.3	14.6	16.2	18.2	21.7	24.1	26.8
70	1.3	2.5	3.6	4.5	5.4	6.2	6.0	7.7	8.5	9.2	10.1	11.0	12.0	13.1	14.4	16.0	17.9	20.5	23.9	26.6
80	1.3	2.4	3.5	4.4	5.3	6.1	6.8	7.6	8.3	9.1	9.9	10.8	11.7	12.0	14.2	15.7	17.7	20.2	23.6	26.3
90	1.2	2.3	3.4	4.3	5.1	5.9	6.7	7.4	8.1	8.9	9.7	10.5	11.5	12.6	13.9	15.4	17.3	19.8	23.3	26.0
100	1.2	2.3	3.3	4.2	5.0	5.8	6.5	7.2	7.9	8.7	9.5	10.3	11.2	12.3	13.6	15.1	17.0	19.5	22.9	25.6

Chart taken from Wood Handbook: Wood as an engineering Material (Agriculture Handbook, 72).
Forest Products Laboratory, U.S. Department of Agriculture

CUTTING ALLOWANCE and MANUFACTURER TOLERANCE (waste factor):

A 10' x 10' room has net 100 square feet (Sq. Ft.) the actual area that will have flooring, but more product is required to allow for cutting which generates unusable pieces.

Carefully measure the net square feet required, adding up multiple areas.

The table gives an approximate recommendation for cutting allowance: Quantities are always rounded up to the nearest box.

Note: Engineered Natural products generally have a 5% manufacturer tolerance which should be added to the Cutting allowance. If defects are greater than the waste factor indicated for your flooring, please contact your local store or call Customer Care at 1-800-366-4204.

Tip: If more than half a box is not available for spares we recommend ordering an extra box.

Please note: Actual cutting waste may be lower or higher based on room layout. E.g. multiple rooms vs. one large area and "pattern" being installed.

Consider carefully before returning boxes. Keeping extra boxes is a great idea and inexpensive insurance against damage, if a repair is needed the product and batch will be the same, and you have options even if the product has been discontinued.

Diagonal installations may require 5% extra material over and above the cutting and manufacturer tolerance allowance.

Net Area SqFt	Total with Cutting Allowance SqFt	% Applied
100	110	10
200	218	9
400	432	8
600	642	7
800	848	6
1000	1050	5
above 1000 SqFt add 5%		

EXPANSION SPACE:

A minimum gap of 1/2" is required between the flooring and all vertical obstructions (walls, door jambs, pipes, staircases, posts, fixtures, built-ins, etc.).

If the room has electric baseboard heaters, leave a minimum of 3/4" between the surface of the flooring and the bottom of the heaters, allowing heat to circulate properly.

NOTE: Gapping and buckling can develop if expansion space requirements are not followed.

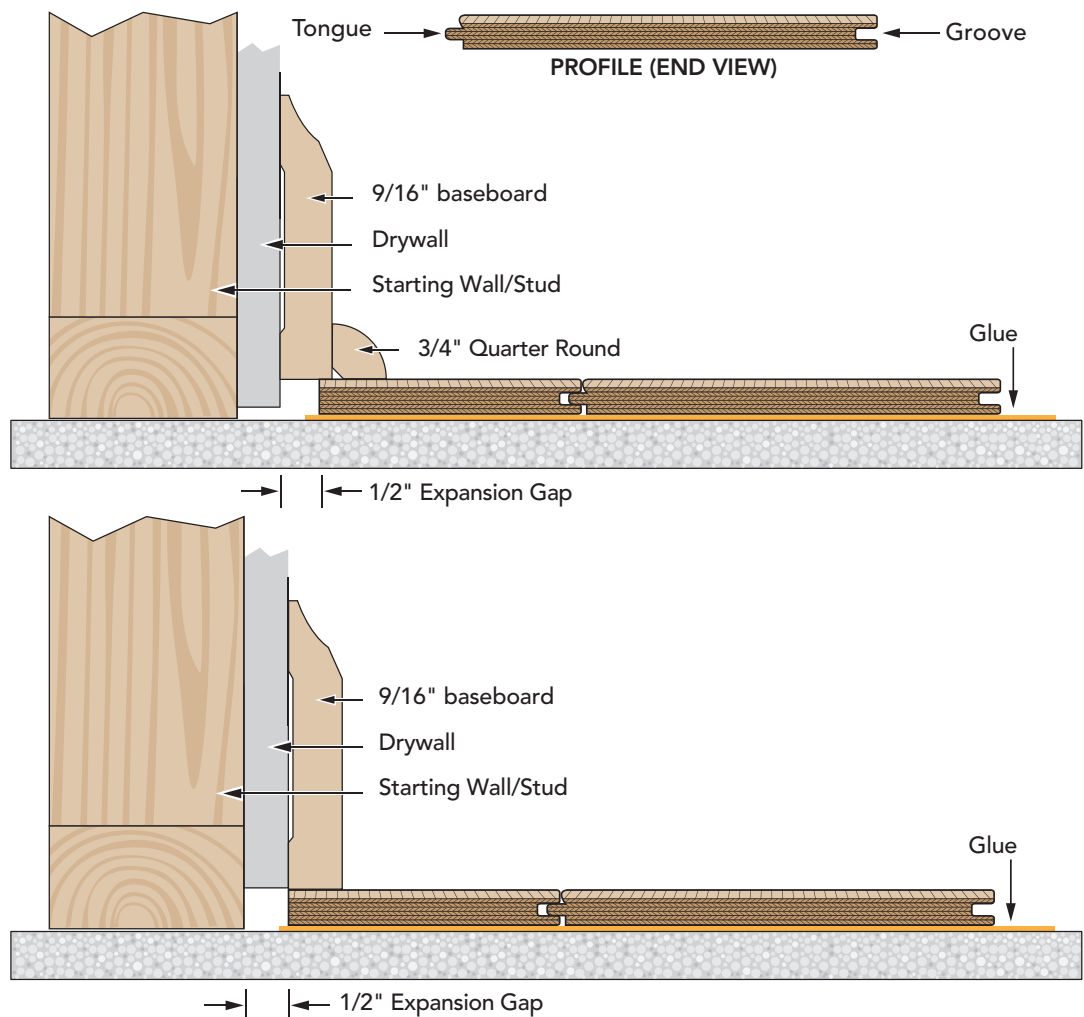

RUN WIDTH AND LENGTH:

Glue down: No limit in run length or width. Flooring must have room to expand and contract freely.

CABINETS / FIXED FIXTURES:

Although not recommended, cabinets may be installed on top of this product (see the product's limited warranty for details).

SUNLIGHT:

This flooring will naturally change color "patina" with prolonged exposure to sunlight. Use of window coverings, shades, or tinting your windows, is recommended to slow this process.

SUBFLOORS NEED TO BE CLEAN – FLAT – DRY:

Wood substrates must be structurally sound and free from movement or deflection.

CLEAN:

Free from contaminants including but not limited to: oil, grease, parting compounds, chemical contaminants, sealing and curing agents, paint, drywall compound, old adhesives such as cutback, solvents, and loose or broken patching agents and other foreign materials that might prevent adhesive bond (refer to the adhesive technical data sheet / install guide).

Free from particles including but not limited to: dust, dirt, and grit.

SUBFLOOR MUST BE FLAT AND SMOOTH

FLAT:

Subfloors must be flat within 1/8" over 6' and 3/16" over 10' and smooth, abrupt peaks and valleys must be avoided. Correct any issues.

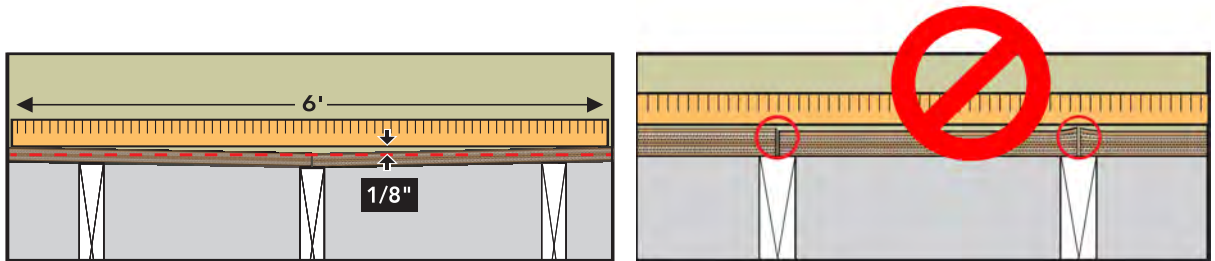

- **Improper substrate or flatness can result in gaps, squeaks, premature wear on surface and poor plank fitting during assembly.**

Correct any issues.

DRY:

See Moisture Testing requirements below.

Do not install this flooring over plywood underlayment attached to concrete, unless it is known that an appropriate moisture barrier has been installed (all applications).

WOOD SUBFLOOR PREPARATION:

- Screw down loose or squeaky sections of plywood and replace areas that are damaged.
- To address flatness concerns sand or plane high spots, 30 lb. roofing felt can be used to build up (in layers) low areas on wood subfloors.
- Substrates that are un-level due to structural deficiencies should be repaired by a licensed contractor.
- **Never apply plastic sheet over wood subfloors.**

• STRUCTURAL REQUIREMENTS:

Note that joist spacing determines minimum subfloor thickness.

Joist spacing 16" on center (OC) or less

– Plywood: Minimum of (5/8", 19/32") Oriented Strand Board (OSB): minimum (3/4", 23/32")

Advantech minimum (3/4", 23/32")

Joist spacing 16" up to 19.2" (OC)

– Plywood: Minimum of (3/4", 23/32") Oriented Strand Board (OSB): minimum of (3/4", 23/32")

Joist spacing over 19.2" up to maximum 24" (OC)

– Plywood: Minimum of (7/8") Oriented Strand Board (OSB): Minimum of (1") or two layers of subflooring or brace between truss/joists in accordance with local building codes.

MOISTURE TESTING:

Use a meter that is species / material adjustable. E.g. Ligno-scanner SDM or mini-Ligno DX/C moisture meter.

- **If using alternate meter check that meter can be used with the subfloor material in question.**
Test sub-floor in multiple locations, with an appropriate wood moisture meter, it's recommended to test 20 location per 1000 square feet and average the results. Moisture readings must not exceed 12%.
- Higher readings indicate a moisture concern that needs to be addressed before installation can begin.
Do not install this flooring over plywood underlayment attached to concrete, unless it is known that an appropriate moisture barrier has been installed.
- For your protection, documenting and saving the test results is recommended.

SUBFLOORS NEED TO BE: CLEAN – FLAT – DRY:

Concrete must be structurally sound and free from movement or deflection.

CLEAN:

Free from contaminants including but not limited to: oil, grease, parting compounds, chemical contaminants, sealing and curing agents, paint, drywall compound, old adhesives such as cutback, solvents, and loose or broken patching agents and other foreign materials that might prevent adhesive bond (refer to the adhesive technical data sheet / install guide).

Free from particles including but not limited to: dust, dirt, and grit.

SUBFLOOR MUST BE FLAT AND SMOOTH

FLAT:

Subfloors must be flat within 1/8" over 6' and 3/16" over 10' and smooth, abrupt peaks and valleys must be avoided.

Improper substrate or flatness can result in gaps, locking mechanism failure and premature wear on surface.

Correct any issues.

DRY:

Follow product use limitations and adhesive manufacturers technical data sheets (TDS) / install guide.

Do not install this flooring over plywood underlayment attached to concrete, unless it is known that an appropriate moisture barrier has been installed (all applications).

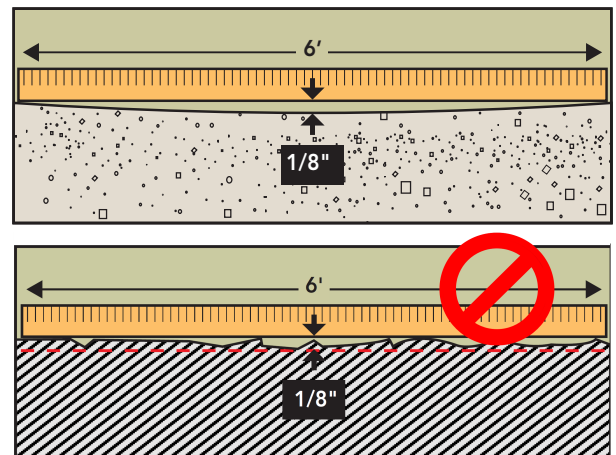

CONCRETE SUBFLOOR PREPARATION:

To address flatness concerns; Grind down high spots using a Diamond Grinder (Shroud and Vacuum) and fill in low spots with an appropriate Portland cement-based patch or self-leveler. Always check compatibility with the adhesive manufacturer).

***CAUTION: Follow OSHA guidelines (29 CFR 1926.1153) regarding silica dust hazards.**

MOISTURE TESTING (Glue down applications):

- The use of adhesives or sealer and adhesive systems with no moisture limits will eliminate the need for testing. E.g. Ultragrip 4 in 1, or Bostik Roll-Cote and approved adhesive. In the event of systems that have a moisture limit. Perform moisture tests regardless of age or grade of the concrete to determine moisture levels. A concrete slab shall be cured a minimum of 60 - 90 days before performing moisture tests. If concrete moisture levels exceed the adhesive manufacturer acceptable limits, do not install the floor.
- **Follow the moisture testing instructions, product limitations and procedural guidelines in the adhesive manufacturer's Technical Data Sheets / Manufacturer Guidelines. The test requirements and limits that apply will vary by product specified..**
- There are only two accepted moisture test methods.
 - 1) The Standard Test Method for Determining Relative Humidity in Concrete Floor Slabs Using in situ Probes (ASTM F 2170)
 - 2) The Standard Test Method for Measuring Moisture Vapor Emission Rate of Concrete Subfloor Using Anhydrous Calcium Chloride (ASTM 1869).
- Note: The use of moisture meters, / plastic sheet tests are not industry accepted quantitative test methods
- For your protection, documenting and saving the test results is recommended.
- Slabs must be free of hydrostatic pressure.

LIGHTWEIGHT ALTERNATIVE SUBFLOORS:

Use over gypsum-based/underlayments is limited to dry, "above-grade" installations where the gypsum has dried hard (not dusty / powdery), with a minimum compressive strength > 2,500 psi for solid hardwood installations. Please refer to adhesive / sealer manufacturer recommendations.

RECOMMENDED PATCHES / LEVELERS:

- Cement Patching- Bostik WebcreteR 95™
- Total Surface Self-Leveling- Bostik SL-175™ (plus Primer Pro) Follow manufacturer's TDS / installation guide.

EXISTING FLOORS:

- This flooring can only be glued down to existing flooring that is properly prepped and approved by the adhesive manufacturer.
- * **Do not install** over wood flooring installed over concrete unless it is known that an appropriate moisture barrier has been installed over the concrete.

UNDERLAYMENT (Double Stick Applications Only):

- Using approved underlayments, your local store can advise on best solution for your situation.

RADIANT HEAT

This flooring is not approved for application over any Radiant heating systems.

USER / OWNER / INSTALLER RESPONSIBILITIES:

Install in good lighting.

- Product installation constitutes acceptance. Visually inspect the product and determine acceptability before installation. Claims will not be accepted regarding visual defects after flooring has been installed. If any planks are unacceptable due to color, finish, milling or any other reason, it is your responsibility to determine to use them, hide them in areas like closets, trim off the imperfection, or not install them at all.
- You should plan on being present during your installation to ensure that all required procedures are completed and boards with visible defects are not installed. It is important to inspect individual boards and to frequently step back to observe the "whole picture" before installation is completed.
- A reasonable amount of installed flooring (up to 25% or 100 sq. ft. whichever is less) is enough to determine acceptance of quality.
- Retain a box label and keep on file with your receipt for future reference.
- If quality issues are suspected stop the installation and call your local store or CUSTOMER CARE at 800-366-4204.

HELPFUL TOOLS: (as needed)

- Tape measure • Pencil • Chalk line • 6' level • Miter saw • Table saw • 60 tooth carbide tip saw blades • Speed square
- Jamb saw • Eye protection • Ear protection • Niosh dust mask • Knee pads • Gloves • Strap Clamps • Stain markers
- Blue painters tape (2080) • PVA wood glue • Compressor with regulator • Air hose • Floor nailer • Brad / Stapler • Drill
- Drill bit set • Hammer • Flat pry bar • Broom • Hygrometer (to monitor in-home humidity) • Species adjustable moisture meter (wood) • Calcium chloride moisture or (RH) Relative Humidity test (concrete) • Approved adhesive remover
- Cloth rags • Color putty

ADDITIONAL NOTES:

- When moving furniture and heavy equipment, use luan board, plywood, or other similar covering to protect the floor.

Each project is unique and different. Installation advice or recommendations are given as a courtesy and not intended to take the place of an installer's visual inspection, expertise or informed judgment, the end user / contractor on-site is ultimately responsible for ensuring that selected products are appropriate for local conditions and / or their final use of the product.

ENGINEERED FLOORING GLUE DOWN METHOD

Groove →  ← Tongue

PROFILE (End View)

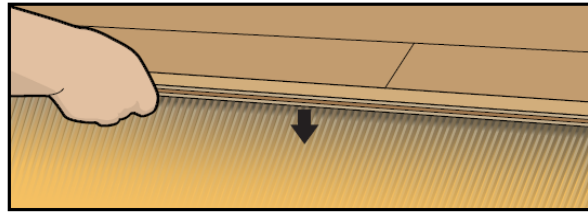

GETTING STARTED:

Remove any existing quarter round, shoe moldings, baseboards and doorway transitions.

Remove existing floor covering as required, check floor flatness per details on previous page and address any issues. Check that all doors will swing open with adequate clearance over the new flooring prior to starting any work.

Important: Do not cut metal door frames before first confirming it does not violate local building and fire codes. Any metal doors must be addressed by a specialist to adjust.

STEP 1. PREPARATION:

Undercut all door casings and jambs with a jamb saw to allow the flooring to slide under the doorjamb. If a baseboard is still in place, extend the undercut about 1" beyond the door frame casing. To find the height to cut the jamb, lay a scrap piece of flooring next to the door frame and lay the saw blade on top. After cut, ensure the floor plus underlayment does not bind, always leave 1/16" clearance under the door jamb / casing for the floor to be able to move freely without vertical restriction. **Check for alarm or other low voltage wiring before cutting.** Ensure that appliances have proper clearance to accommodate the new flooring.

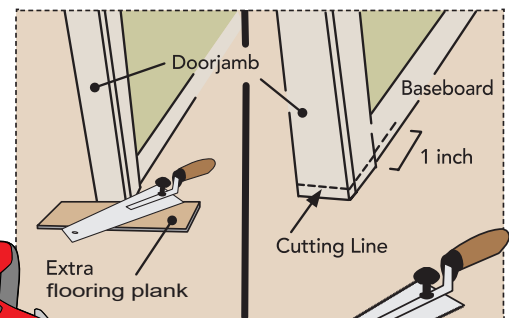

Electric jamb saw

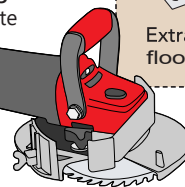

Door jamb saw

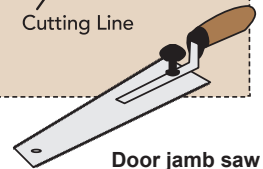

STEP 2. LAYOUT:

Determine which direction the planks will be installed. Install Engineered wood flooring perpendicular or on a diagonal to the flooring joist unless subfloor is modified per NWFA Installation Guidelines. Considerations are fireplaces, doors, cabinets, and transitions. For best appearance, full planks are desirable at the focal point and most cases it is the longest unbroken wall in the room.

Installers: It is advisable to determine the installation layout and direction (North/South vs East/West) with the end user.

Install recommended underlayment as required.

Preparation of planks for the starting row when needed:

To avoid very narrow pieces at finish wall, measure the distance between the starting wall to the finish wall, then divide this number by the width of the flooring planks. The fraction is the width of the last plank.

E.g. for a 12' room:

Start – Finish = 144" – 1" (1/2" expansion x 2) = 143"

Width of plank = 5"

$143 \div 5 = 28.6$

Twenty eight full planks are required and last will be fraction x plank width.

$5" \times 0.6 = 3"$

If width of last plank is less than 2.5", balance by cutting (Rip) starting row of planks accordingly.

NOTE: If a narrow strip is unavoidable for the last row, the final two rows can be glued together using PVA tongue and groove adhesive at the long seams to avoid board separation.

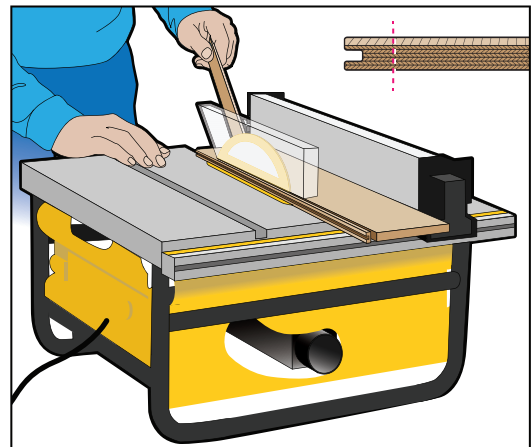

STEP 3. ESTABLISH A WORKING LINE

Start by snapping a chalk line parallel to your starting wall. The distance from the wall to the line will be the width of the plank used on first row plus the 1/2" expansion space.

Use wedged spacers for a 1/2" expansion gap between the flooring and the walls.

Be sure to keep a 1/2" gap around all vertical obstructions, e.g. newel posts, raised hearths, upright pipes or other fixtures.

Install the flooring with the tongue side facing away from the starting wall (use long straight planks for the first two rows).

Use wedged spacers to maintain minimum expansion gap between the flooring and the walls. Place spacers adjacent to each plank joint, and at the beginning and end of each row.

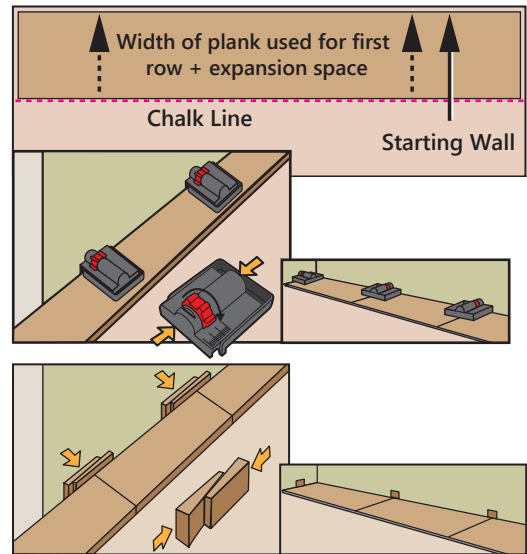

STEP 4. THE FIRST ROW

- Using an approved trowel and wood flooring adhesive, spread the glue between the wall and first chalk line.
- Working left to right, lay the first plank against the wall (adjust spacers to ensure row lines up with your working line) using full length planks (the groove edge should follow along the working line). Continue laying the first row until you reach the other wall.

Note: See Step 6 for cutting the last plank in row to fit.

- Allow the first row to set up prior to installing additional rows. This prevents the first row from moving when balance of room is installed.

STEP 5. IMPORTANT:

When laying planks, avoid starting or ending rows with cuts (short side) less than 8" in length. Stagger the end joints from row to row, by at least 8" to ensure the structural integrity of your floor and a pleasing appearance.

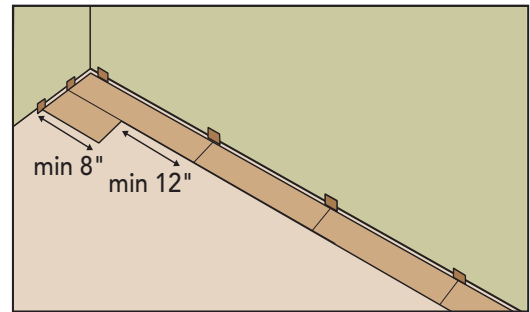

Pay close attention to avoid "stair step" or "H-patterns" appearing in the flooring.

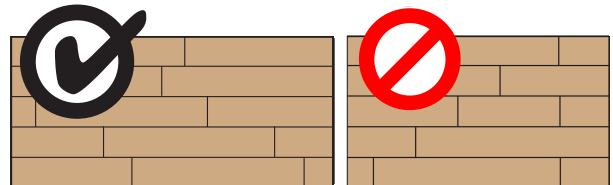

Measure out from your first completed row the width of 5 planks on each side of room (do not include the tongue), and pop another chalk line. This chalk line will run parallel to the first chalk line.

- Rack out 5 rows of flooring starting about an inch beyond this new chalk line. Be sure to pull from several flooring boxes at a time to mix color, while keeping proper seam stagger, loose lay/rack flooring install randomly.
 - Using an approved trowel and wood flooring adhesive, spread the glue between the first completed row and second chalk line. (See adhesive recommendations below)
 - Progressively lay-in the next rows by inserting the tongue into the groove of the previous row at a 30 degree angle, then drop board into adhesive. Avoid dragging or sliding boards together as this can trap or squeeze glue up in between the boards creating gaps. Continue working 5 rows together. The last board in each row will need to be cut to fit (**see Step 6.**). The balance of the cut board may be used to start a new row if is at least 8" long.
 - A tapping block can be used to gently tap the boards into proper position.
- During installation, minimize end gaps by temporarily locking-in each completed row with spacers (scrap flooring works for this) placed at the beginning and end of each row, remove when glue has dried.

- As you install, apply #2080 blue painters tape “stretched-tightly across” plank surface perpendicular to the installed floor to hold the planks together until glue sets up.
- Remove any wet adhesive that gets on the floor finish right-away using mineral spirits or adhesive manufactures adhesive remover product.
NOTE: incorrect tape can damage the finish
Do not leave tape on for more than 24 hrs

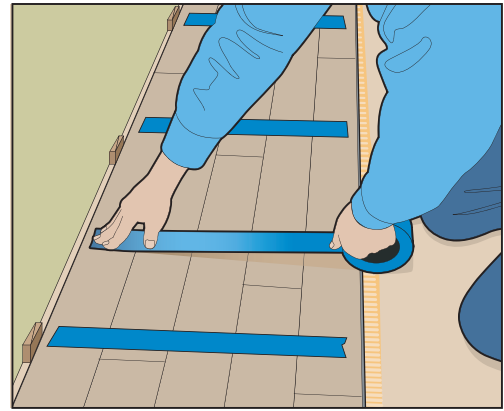

Alternative Method:

Flooring straps may be used to keep planks reasonably tight, care should be taken not to over tighten the floor. Over-tightening may adversely affect floor and can result in glue-bond failure, seam peaking, twisted boards or out of square flooring alignment.

- Weights may be required to ensure adequate contact with the subfloor prior to adhesive setup.
 - Continue adding new chalk lines using the previous techniques. Spread the adhesive and continue installing five rows at a time until job is complete. Tape planks together as needed to keep them from seperating.
- ▽ Remove any wet adhesive that gets on the floor finish right away using mineral spirits or adhesive manufactures adhesive remover product.

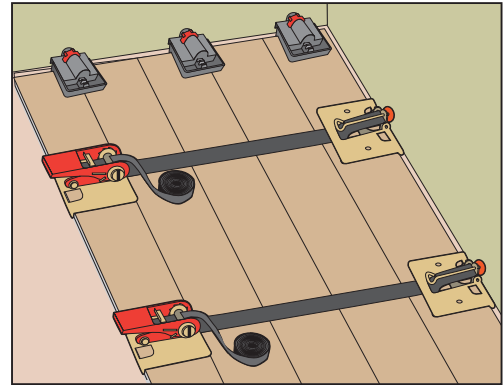

STEP 6. CUTTING END-OF-ROW BOARDS

The last board in each row must be cut to fit, while still maintaining proper expansion gap at the walls. Here's how:

1. Flip the plank over, end-to-end.
2. Lay the flipped board next to the row of planks and mark it on the face.
3. Cut the plank at the mark
4. Flip the plank back over and install as normal.

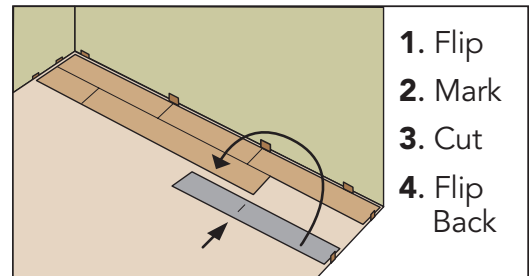

RECOMMENDED ADHESIVES:

- Use LL wood flooring Adhesives and sealer/adhesive systems that are approved for use with engineered wood flooring products for this application.
- See your local store or contact Customer Care @ 1-800-366-4204.
- Please check the manufacturers' Technical Data Sheets "TDS" and instructions to ensure the adhesive is approved for your type of installation and the details of subfloor prep, moisture and pH testing, approved substrates, trowel sizes, cure times, coverage and other important information.
- TDS sheets can be found at www.llflooring.com and on the adhesive product pages.

STEP 7. POST-INSTALLATION:

- Remove blue painters tape after 8 to 10 hours being on the flooring.
- After installation, refer to adhesive manufacturer's guidelines as to cure time and when foot traffic and furniture can go back onto your new flooring.
- Protect flooring before moving any heavy furniture or appliances.
- Fill in minor gaps with close matching filler.
- Check for adhesive on floor finish and remove with appropriate adhesive manufacture remover.

FITTING AROUND IRREGULAR SHAPED OBJECTS:

Make a template to fit around pipes or irregular shaped objects. Place the pattern upon the plank and trace. Cut along the trace lines using a jig saw, and install plank. Note: Be sure to leave the recommended expansion space around all fixed objects, cabinetry and metal door jambs.

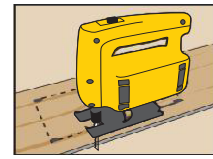

PIPES:

When a pipe is passing through the floor make a hole on the plank 1" greater than the diameter of the pipe, cut the plank with a 45° angle towards the hole. The cut-off piece edges are glued in the position again.



When there is single pipe on a wall, you can plan to have the end-joints meet at pipe, drill and install as shown.

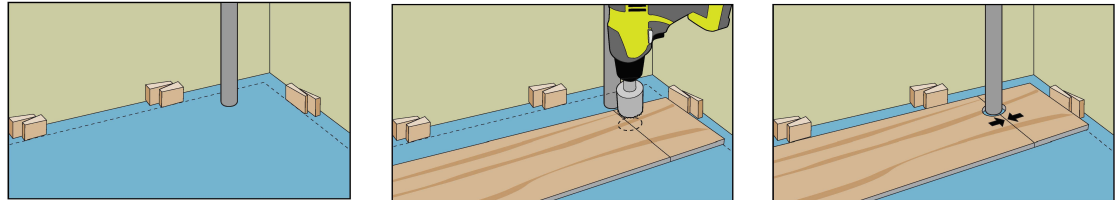

If there are multiple or larger pipes passing through the floor make hole(s) on the plank 1" greater than the diameter of the pipe, cut the plank with a 45° angle towards the hole. The cut-off piece edges are glued in the position again. Glue pieces together and engage with adhesive on subfloor for added stability.

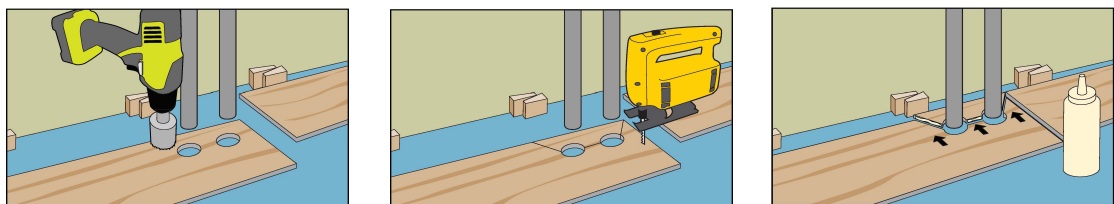

STEP 8.

To ensure the floor is able to "expand & contract" freely, be sure to affix baseboards or moldings to the walls, not to the floors.

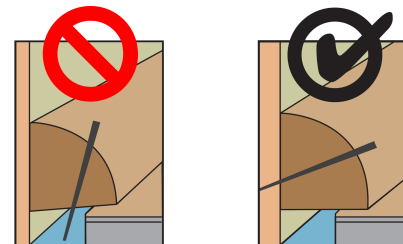

STEP 9. TRANSITIONS

In areas where your new floor meets other types of flooring, such as carpet or tile, select an appropriate molding to get a professional looking and safe transition.

Threshold moldings transition from floor to carpet and are used at sliding doors, raised hearths, etc.

Reducer moldings transition from floors to hard surfaces that are lower than the floor, such as vinyl or VCT tile.

Stair Nose moldings are used when the new floor edge is at a step-down; Example: when the flooring meets at the top of a stairway "going down".

T-Moldings cover expansion spaces at doorways, and they transition from your new floor to other hard surfaces of similar height.

3/4" Quarter Round moldings are used to cover expansion spaces between the baseboards and the flooring.

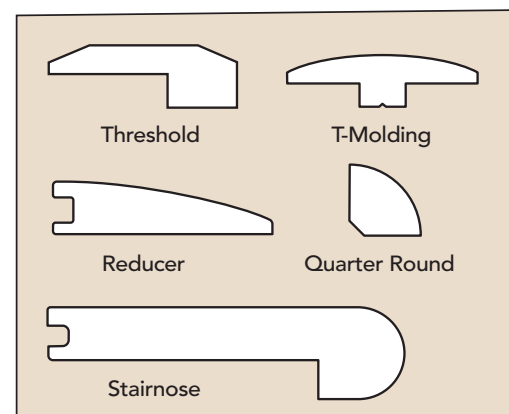



REPAIRS:

Save extra planks from the initial order in the event that installed planks become damaged and repairs are needed. This will ensure lot number and shading compatibility.

EDGE GLUE FLOAT * [Nail Down/Nail Glue-Assist Method Click Here](#) * [Glue Down Method Click Here](#) * [Wall Application Click Here](#)

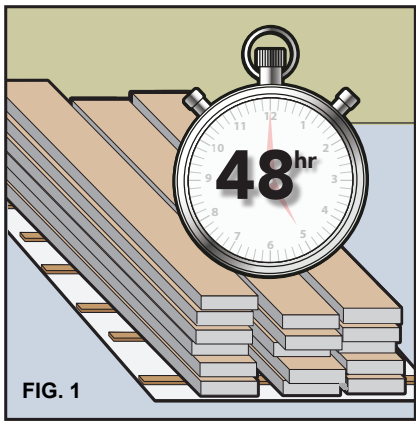
Save time & avoid frustration! Please read these entire instructions before starting your installation, and A.I.M. for success!

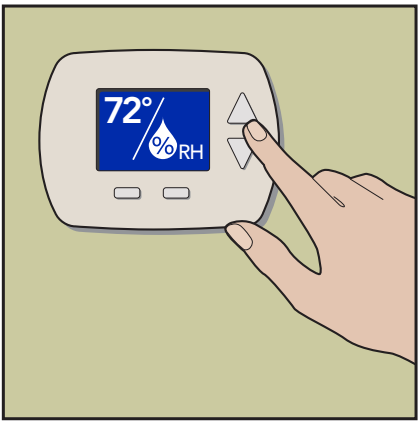
<p>AIM</p>	<p>AIM</p>	<p>AIM</p>
 <p>FIG. 1</p>		
<p>Acclimate Completely Acclimate your flooring to your home environment. Time for acclimation will vary. Always check using a meter. Acclimation will ensure your flooring looks great for years to come</p>	<p>Install Correctly Take time to review LL Flooring’s installation guidelines and follow the National Wood Flooring Association Guidelines to ensure that your installation goes well from beginning to end.</p>	<p>Maintain Environment The ideal Relative Humidity (RH) range for Hardwood is 30%–50% at a temperature of 60°–80°F. It is acceptable in some households that this range may be higher or lower, but extreme fluctuations in RH must be avoided*.</p>

*See Temperature and Relative Humidity for more details.

? **Need Help?** To obtain installation assistance or product information concerning this flooring, contact the store of original purchase, or call the LL Flooring’s customer care at 800-366-4204.

! **WARNING! DO NOT SAND, DRY SWEEP, DRY SCRAPE, DRILL, SAW, BEADBLAST OR MECHANICALLY CHIP OR PULVERIZE EXISTING RESILIENT FLOORING, BACKING, LINING FELT, ASPHALTIC “CUTBACK” ADHESIVES OR OTHER ADHESIVES.** These products may contain asbestos fibers and/or crystalline silica. Avoid creating dust. Inhalation of such dust is a cancer and respiratory tract hazard. Smoking by individuals exposed to asbestos fibers greatly increases the risk of serious bodily harm. Unless positively certain that the product to be removed is a non-asbestos containing material, you must presume it contains asbestos. Regulations may require that the material be tested to determine asbestos content. See current edition of the Resilient Floor Covering Institute (RFCI) publication, “Recommended Work Practices for Removal of Resilient Floor Coverings” for detailed information and instructions on removing all resilient covering structures. For current information, go to www.rfci.com.

! **LEAD WARNING:** Some paints and finishes in homes built before 1978 may contain lead. Exposure to excessive amounts of lead dust presents a health hazard. Prior to removing or sanding, comply with all applicable federal, state, and local laws, and reference the publication “Lead-Based Paint: Guidelines for Hazard Identification and Abatement in Public and Indian Housing” available from the United States Department of Housing and Urban Development regarding (1) appropriate methods for identifying lead-based paint and removing such paint; and (2) any licensing, certification, and training requirements for persons performing lead abatement work.

! **MOLD AND MILDEW WARNING:** Prior to removing an existing resilient floor or when installing a new floor, if there are visible indications of mold or mildew or the presence of a strong musty odor in the installation area, the source of the problem should be identified and corrected before proceeding with the flooring work. Excessive moisture in the subfloor could promote mold, mildew, and other moisture related issues like the trapping of moisture emissions under the flooring, which may contribute to an unhealthy indoor environment. Mold has the potential to cause health problems and may produce allergens, irritants, and in some cases, potentially toxic substances. Before installing the new resilient flooring, ensure the underlayment and/or subfloor is allowed to thoroughly dry and that any residual effect of excessive moisture, mold, or structural damage has been corrected. Remediation measures may require structural repairs such as replacing the contaminated underlayment and/or subfloor, cleanup measures using appropriate protection and biocide, or hiring a professional mold and mildew remediation contractor. Consult EPA mold guidelines on EPA’s website at <https://www.epa.gov/mold>

! **WARNING:** Drilling, sawing, sanding or machining wood products can expose you to wood dust, a substance known to the State of California to cause cancer. Avoid inhaling wood dust or use a dust mask or other safeguards for personal protection. For more information go to www.P65Warnings.ca.gov/wood

RECOMMENDED USE:

- Residential or light commercial* interior use only. *See the product's limited warranty for details.
- **Do not install in wet areas like patios and showers, or exterior areas. Do not install in boats, moving vehicles or over radiant heat.**

Grade: On, above and below Grade.

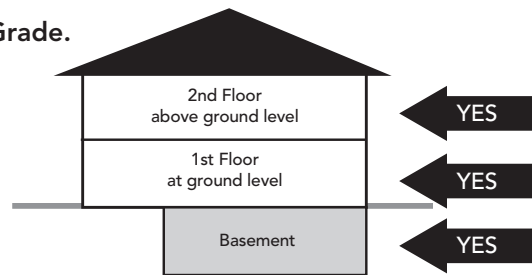

JOBSITE CONDITIONS:

- The building should be enclosed with all doors and windows in place.
- **Prior to delivery and install:** All wet works (e.g. drywall taping, texture, painting, stucco etc.) should be complete and allowed to dry. The rooms should be at normal "lived-in" conditions with HVAC operational for at least one week prior to the installation when home is so equipped.
- When installing in rooms over basements and garages, ensure they are dry and well ventilated.
- Crawlspace must be dry with a minimum 18" from the bottom of the floor joist to the ground, Crawl space earth (or thin concrete slab) should be covered 100 percent by a vapor retarder of black polyethylene (minimum 6 mil) or any recommended puncture-resistant membrane, such as Class C, meeting ASTM D1745. Ventilation shall be per local building codes.
- To avoid damages to the floor's finish, all construction activity should be completed before installing this floor.
- All gutters should be in place and functioning properly. Yard grading should be sloped to run water away from the home foundation.
- The installer - not the manufacturer or retailer - is responsible for making sure that the site conditions are appropriate prior to installation of this floor.

ACCLIMATION: 48 Hours

- Stack boxes no more than eight cartons high in areas to receive new flooring (remove plastic from outside of boxes if present). Ensure each layer is evenly supported to prevent distortion. Elevate stack using 2 x 4's as illustrated in Fig. 1 above.
- **On concrete; place a layer of 6 mil poly down first during the acclimation process.**
- Extended acclimation time should be anticipated and may be required. Time is not the determining factor; moisture testing is required to confirm that product is acclimated. Use a meter that is species adjustable, E.g. Ligno-scanner SDM or mini-Ligno DX/C moisture meter. If using alternate meter check with manufacturer that meter can be used with the wood species that you are installing.
- Check the moisture content of multiple planks. It's recommended to randomly test 40 planks for every 1000 square feet of flooring, the flooring's average moisture content must be within 4% of the subfloor.
- Keep a permanent record of all readings.

TEMPERATURE:

For best product performance, ensure the temperature in the home is between 60° and 80° F before, during, and after installation and for the life of the flooring.

RELATIVE HUMIDITY:

For best performance, flooring should be ideally conditioned, installed and maintained to consistent indoor temperatures of 60°- 80°F and relative humidity of 30% - 70% (not to exceed a 30% fluctuation in relative humidity, before, during and after the installation and for the life of the flooring. Ideal interior environmental conditions will vary from region to region and jobsite to jobsite, the relative humidity figures on your project maybe higher or lower.

The key is to ensure that the change in relative humidity stays within a 30% range (e.g.30% to 60% or 35% to 65% etc...) and does not fluctuate beyond 30% for sustained periods, enough to affect the flooring. Home environments where the relative humidity drops below 30% or exceed 70% are not recommended.

Not following the written recommendations can negatively impact board performance and may result in excessive movement, squeaks, board gapping, board-edge cupping, cracks, twists, finish splits, flaking, chipping, fading and other related issues.

Any home that may have a sustained change in relative humidity greater than 30% fluctuation needs an HVAC system equipped with a humidifier or dehumidifier to regulate the interior environment within a 30% range of fluctuation. Installing hardwood in an environment that is not maintained can be detrimental to the flooring.

The map below can be used to calculate what the optimum baseline or average moisture content of interior wood products should be prior to installation for each state and region. The first number indicates the average moisture content of wood during the wintertime (months having lower humidity), and the second number indicates the average moisture content during the summer time or (months having higher humidity).

To calculate the optimal baseline or average wood moisture content in your state or region, add the high season number and low season number together then divide by two. Example: If your state or region has an expected low of 6% to a high of 12% moisture content, the average baseline moisture content of the wood before installation would be 9%. The goal is to acclimate the flooring to this average figure and then the installation can begin.

Very dry or humid regions of the country usually require extended conditioning to balance the new flooring to the environment it will service.

Summer / Winter Moisture Map

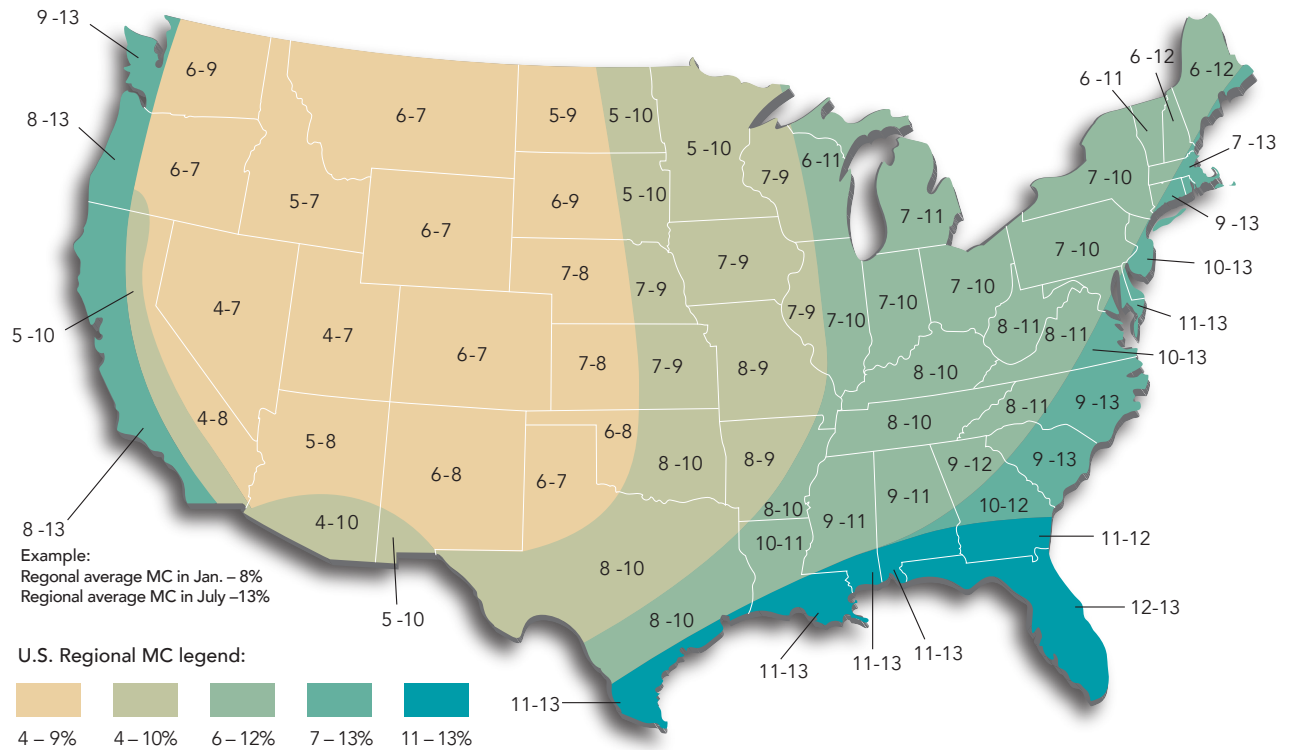

The effects of Temperatures and Humidity on wood flooring

Wood products are sensitive to moisture, temperature and humidity. Refer to the chart below to better understand the best in-home environmental relationship between relative humidity (RH) and temperature and its effects on wood moisture content. Determine the current temperature and RH within your home with a hygrometer. Find the combination of temperature and RH in your area on the chart (temperature variations are listed on the left side of the chart, humidity variations are listed along the bottom).

Example: The target or ideal moisture content for wood products is shown in the shaded area to be within 6.1% to 9.4%. Wood flooring will perform best when the interior environment is controlled to stay within a relative humidity range of 30% to 50% and a temperature range of 60° to 80° Fahrenheit. (In some geographical areas, the ideal humidity range might be higher or lower, 30% to 60% or 35% to 65% for example.) It is critical to maintain the relative humidity in your home to not fluctuate more than 30% at any given time of the year. Eng' Hardwood flooring installed in areas with a wider variation in RH (fluctuation in RH of more than 30%) can negatively impact board performance and may result in excessive movement (expansion / contraction, squeaks, board gapping, board-edge cupping, finish splits and other related issues).

Moisture Content of Wood at Various Temperatures and Relative Humidity Readings

°F	5	10	15	20	25	30	35	40	45	50	55	60	65	70	75	80	85	90	95	98
30	1.4	2.6	3.7	4.6	5.5	6.3	7.1	7.9	8.7	9.5	10.4	11.3	12.4	13.5	14.9	16.5	18.5	21.0	24.3	26.0
40	1.4	2.6	3.7	4.6	5.5	6.3	7.1	7.9	8.7	9.5	10.4	11.3	12.4	13.5	14.9	16.5	18.5	21.0	24.3	26.0
50	1.4	2.6	3.7	4.6	5.5	6.3	7.1	7.9	8.7	9.5	10.4	11.3	12.4	13.5	14.9	16.5	18.5	21.0	24.3	26.0
60	1.3	2.5	3.6	4.6	5.4	6.2	7.0	7.8	8.6	9.4	10.2	11.1	12.1	13.3	14.6	16.2	18.2	21.7	24.1	26.8
70	1.3	2.5	3.6	4.5	5.4	6.2	6.0	7.7	8.5	9.2	10.1	11.0	12.0	13.1	14.4	16.0	17.9	20.5	23.9	26.6
80	1.3	2.4	3.5	4.4	5.3	6.1	6.8	7.6	8.3	9.1	9.9	10.8	11.7	12.0	14.2	15.7	17.7	20.2	23.6	26.3
90	1.2	2.3	3.4	4.3	5.1	5.9	6.7	7.4	8.1	8.9	9.7	10.5	11.5	12.6	13.9	15.4	17.3	19.8	23.3	26.0
100	1.2	2.3	3.3	4.2	5.0	5.8	6.5	7.2	7.9	8.7	9.5	10.3	11.2	12.3	13.6	15.1	17.0	19.5	22.9	25.6

Chart taken from Wood Handbook: Wood as an engineering Material (Agriculture Handbook, 72).
Forest Products Laboratory, U.S. Department of Agriculture

CUTTING ALLOWANCE and MANUFACTURER TOLERANCE (waste factor):

A 10' x 10' room has net 100 square feet (Sq. Ft.) the actual area that will have flooring, but more product is required to allow for cutting which generates unusable pieces.

Carefully measure the net square feet required, adding up multiple areas.

The table gives an approximate recommendation for cutting allowance: Quantities are always rounded up to the nearest box.

Note: Engineered Natural products generally have a 5% manufacturer tolerance which should be added to the Cutting allowance. If defects are greater than the waste factor indicated for your flooring, please contact your local store or call Customer Care at 1-800-366-4204.

Tip: If more than half a box is not available for spares we recommend ordering an extra box.

Please note: Actual cutting waste may be lower or higher based on room layout. E.g. multiple rooms vs. one large area and "pattern" being installed.

Consider carefully before returning boxes. Keeping extra boxes is a great idea and inexpensive insurance against damage, if a repair is needed the product and batch will be the same, and you have options even if the product has been discontinued.

Diagonal installations may require 5% extra material over and above the cutting and manufacturer tolerance allowance.

Net Area SqFt	Total with Cutting Allowance SqFt	% Applied
100	110	10
200	218	9
400	432	8
600	642	7
800	848	6
1000	1050	5
above 1000 SqFt add 5%		

EXPANSION SPACE:

A minimum gap of 1/2" is required between the flooring and all vertical obstructions (walls, door jambs, pipes, staircases, posts, fixtures, built-ins, etc.).

If the room has electric baseboard heaters, leave a minimum of 3/4" between the surface of the flooring and the bottom of the heaters, allowing heat to circulate properly.

NOTE: Gapping and buckling can develop if expansion space requirements are not followed.

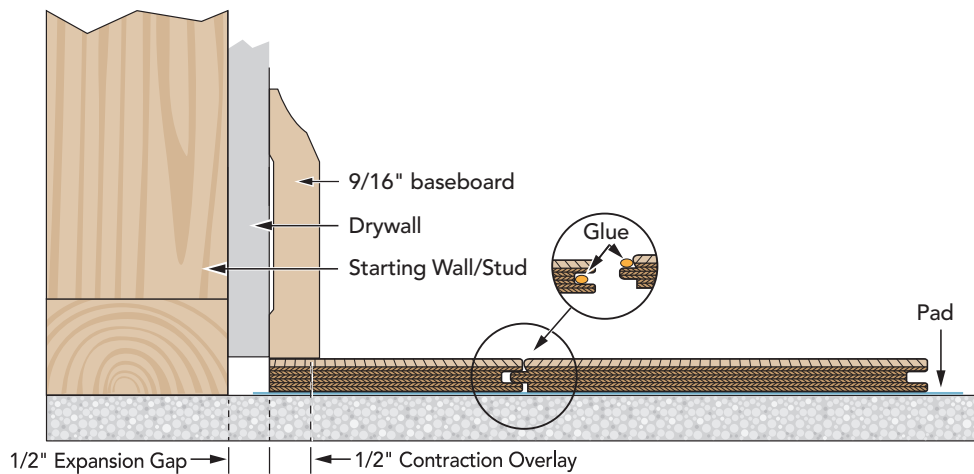
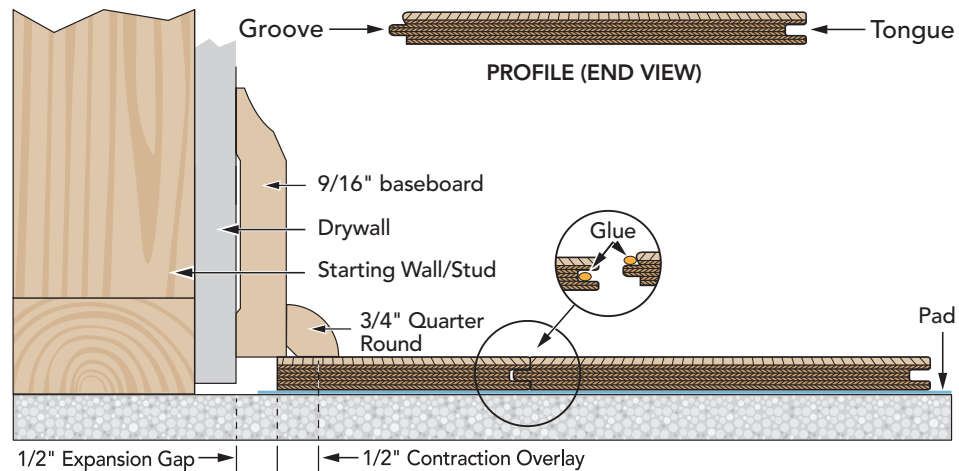

RUN LENGTH AND WIDTH:

Floating Applications: 30' maximum in length and 30' in width of continuously connected flooring.

In floating applications, transitions are always required at all doorways, adjoining rooms, archways, connections in hallways and when runs exceed the above length and width.

NOTE: When installed in a "floating" application: this flooring cannot be glued, nailed, screwed or otherwise fixed or attached (e.g. door stopper, closet-track, stair rails, etc.) to the subfloor in any way. It must have room to expand and contract freely. Gapping and buckling can develop if expansion space and t-moldings, requirements are not followed.

CABINETS / FIXED FIXTURES:

Do not install fixed cabinets, islands or other fixed objects on top of flooring.

SUNLIGHT:

This flooring will naturally change color "patina" with prolonged exposure to sunlight. Use of window coverings, shades, or tinting your windows, is recommended to slow this process.

SUBFLOORS NEED TO BE CLEAN – FLAT – DRY:

Wood substrates must be structurally sound and free from movement or deflection.

CLEAN:

Free from contaminants including but not limited to: oil, grease, parting compounds, chemical contaminants, sealing and curing agents, paint, drywall compound, old adhesives such as cutback, solvents, and loose or broken patching agents and other foreign materials that might prevent adhesive bond (refer to the adhesive technical data sheet / install guide). Free from particles including but not limited to: dust, dirt, and grit.

SUBFLOOR MUST BE FLAT AND SMOOTH

FLAT:

Subfloors must be flat within 1/8" over 6' and 3/16" over 10' and smooth, abrupt peaks and valleys must be avoided. Correct any issues.

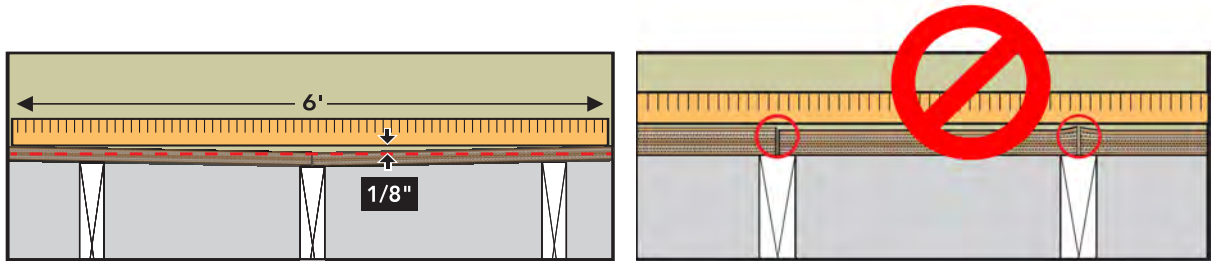

- **Improper substrate or flatness can result in gaps, squeaks, premature wear on surface and poor plank fitting during assembly.**
Correct any issues.

DRY:

See Moisture Testing requirements below.

Do not install this flooring over plywood underlayment attached to concrete, unless it is known that an appropriate moisture barrier has been installed (all applications).

WOOD SUBFLOOR PREPARATION:

- Screw down loose or squeaky sections of plywood and replace areas that are damaged.
- To address flatness concerns sand or plane high spots, 30 lb. roofing felt can be used to build up (in layers) low areas on wood subfloors.
- Substrates that are un-level due to structural deficiencies should be repaired by a licensed contractor.
- **Never apply plastic sheet over wood subfloors.**
- **STRUCTURAL REQUIREMENTS:**
Note that joist spacing determines minimum subfloor thickness.
Joist spacing 16" on center (OC) or less
 - Plywood: Minimum of (5/8", 19/32") Oriented Strand Board (OSB): minimum (3/4", 23/32")
Advantech minimum (3/4", 23/32")**Joist spacing 16" up to 19.2" (OC)**
 - Plywood: Minimum of (3/4", 23/32") Oriented Strand Board (OSB): minimum of (3/4", 23/32")**Joist spacing over 19.2" up to maximum 24" (OC)**
 - Plywood: Minimum of (7/8") Oriented Strand Board (OSB): Minimum of (1") or two layers of subflooring or brace between truss/joists in accordance with local building codes.

MOISTURE TESTING:

Use a meter that is species / material adjustable. E.g. Ligno-scanner SDM or mini-Ligno DX/C moisture meter.

- If using alternate meter check that meter can be used with the subfloor material in question.

Test sub-floor in multiple locations, with an appropriate wood moisture meter, it's recommended to test 20 location per 1000 square feet and average the results. Moisture readings must not exceed 12%.

- Higher readings indicate a moisture concern that needs to be addressed before installation can begin.

Do not install this flooring over plywood underlayment attached to concrete, unless it is known that an appropriate moisture barrier has been installed.

- For your protection, documenting and saving the test results is recommended.

SUBFLOORS NEED TO BE: CLEAN – FLAT – DRY:

Concrete must be structurally sound and free from movement or deflection.

CLEAN:

Free from contaminants including but not limited to: oil, grease, parting compounds, chemical contaminants, sealing and curing agents, paint, drywall compound, old adhesives such as cutback, solvents, and loose or broken patching agents and other foreign materials that might prevent adhesive bond (refer to the adhesive technical data sheet / install guide).

Free from particles including but not limited to: dust, dirt, and grit.

SUBFLOOR MUST BE FLAT AND SMOOTH

FLAT:

Subfloors must be flat within 1/8" over 6' and 3/16" over 10' and smooth, abrupt peaks and valleys must be avoided.

Improper substrate or flatness can result in gaps, locking mechanism failure and premature wear on surface.

Correct any issues.

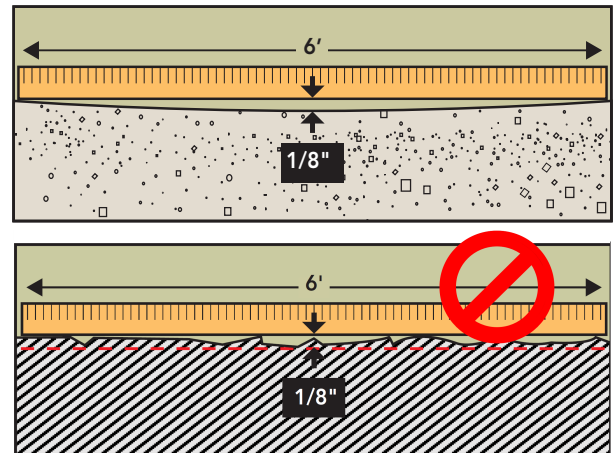

DRY:

Follow product use limitations and adhesive manufacturers technical data sheets (TDS) / install guide.

Do not install this flooring over plywood underlayment attached to concrete, unless it is known that an appropriate moisture barrier has been installed (all applications).

CONCRETE SUBFLOOR PREPARATION:

: @C5HB; '5 DD@7 5HCBG.'

- 6 mil polyethylene moisture barrier- seams overlapped 4"- 6" and taped using a waterproof adhesive tape (e.g. duct tape) must be used or LL underlayment with a water vapor permeance of 0.1 perm or less when tested in accordance with the ASTM E96.
- **Roll-Cote by Bostik**, a new roller applied moisture barrier alternative to 6 mil poly. Two coats of Roll-Cote must be applied to perform as a Moisture-Vapor-Barrier. Follow manufacturer's TDS / installation guide. [Click here for complete details](#)
- Do not proceed with installation if concrete is wet or shows sign of dampness. Excessive moisture could lead to mold / mildew. (Underlayment's with a vapor retarder still require this moisture barrier).
- To address flatness concerns; Grind down* high spots and fill in low spots with an appropriate Portland cement based patch or self-leveler (allow to cure fully) prior to installing floor. *CAUTION: Follow OSHA guidelines (29 CFR 1926.1153) regarding silica dust hazards.
- 15 / 30 lb. roofing felt or vinyl tile can be used to build up (in layers) low areas on concrete subfloors.

LIGHTWEIGHT ALTERNATIVE SUBFLOORS:

Installation over gypsum-based slabs is limited to above grade, floating installations only. Do not use 6mm poly over lightweight concrete e.g. Gypcrete use gypsum-based patch or self-leveler (allow to cure fully) prior to installing floor.

*CAUTION: Follow OSHA guidelines (29 CFR 1926.1153) regarding silica dust hazards.

RECOMMENDED PATCHES / LEVELING COMPOUNDS:

- Cement Patching- Bostik WebcreteR 95™
- Total Surface Self-Leveling- Bostik SL-175™ (plus Primer Pro) *Follow manufacturer's TDS / installation*

EXISTING FLOORS:

- This flooring can be floated over existing clean, flat, dry, well bonded/secured tile, vinyl and wood flooring*.
- ★ **Do not install** over wood flooring installed over concrete unless it is known that an appropriate moisture barrier has been installed over the concrete.
- Do not install over cushioned vinyl flooring, or existing floating floor products.
- Do not install over carpet and padding.

UNDERLAYMENT

- Quality Underlayment is recommended. It can help smooth out minor subfloor imperfections, provide moisture protection over all subfloors and have added insulation and sound control properties.
- NOTE: Some acoustical “vapor retarder” underlayments have limits of moisture protection and are not a substitute for a 6 mil polyethylene moisture barrier. Underlayments that have a water vapor permeance of 0.1 perm rating or less when tested in accordance with ASTM E96 can be used in place of 6 mil poly sheeting.
- **We recommend the following underlayments to maintain your manufacturer's warranty and provide moisture protection of 0.1 perm rating or less:** [QuietWalk Max](#) (10056877), [QuietWalk Versa](#) (10056873) [QuietBoard](#) (10056807) and [EcoSilencer Max](#) (10056803).
- Be sure to follow manufacturer's installation guidelines to include additional waterproof tape as required.
- **Important: Additional underlayment / padding is not recommended for thin (4mm and below) vinyl flooring products.**
- This flooring is waterproof, however, moisture intrusions from concrete via hydrostatic pressure, flooding, or plumbing leaks, along with high levels of alkalinity, can affect floor coverings over time.
- Moisture can also be trapped below the flooring and create mildew or mold
- LL offers a wide variety of underlayments, please call 1-800-366-4204 or see your local store for recommendations

RADIANT HEAT

This flooring is not approved for application over any Radiant heating systems.

USER / OWNER / INSTALLER RESPONSIBILITIES:

Install in good lighting.

- Product installation constitutes acceptance. Visually inspect the product and determine acceptability before installation. Claims will not be accepted regarding visual defects after flooring has been installed. If any planks are unacceptable due to color, finish, milling or any other reason, it is your responsibility to determine to use them, hide them in areas like closets, trim off the imperfection, or not install them at all.
- You should plan on being present during your installation to ensure that all required procedures are completed and boards with visible defects are not installed. It is important to inspect individual boards and to frequently step back to observe the “whole picture” before installation is completed.
- A reasonable amount of installed flooring (up to 25% or 100 sq. ft. whichever is less) is enough to determine acceptance of quality.
- Retain a box label and keep on file with your receipt for future reference.
- If quality issues are suspected stop the installation and call your local store or CUSTOMER CARE at 800-366-4204.

HELPFUL TOOLS: (as needed)

- Tape measure • Pencil • Chalk line • 6' level • Miter saw • Table saw • 60 tooth carbide tip saw blades • Speed square
- Jamb saw • Eye protection • Ear protection • Niosh dust mask • Knee pads • Gloves • Strap Clamps • Stain markers
- Blue painters tape (2080) • PVA wood glue • Compressor with regulator • Air hose • Floor nailer • Brad / Stapler • Drill
- Drill bit set • Hammer • Flat pry bar • Broom • Hygrometer (to monitor in-home humidity) • Species adjustable moisture meter (wood) • Calcium chloride moisture or (RH) Relative Humidity test (concrete) • Approved adhesive remover
- Cloth rags • Color putty

ADDITIONAL NOTES:

- When moving furniture and heavy equipment, use luan board, plywood, or other similar covering to protect the floor.

Each project is unique and different. Installation advice or recommendations are given as a courtesy and not intended to take the place of an installer's visual inspection, expertise or informed judgment, the end user / contractor on-site is ultimately responsible for ensuring that selected products are appropriate for local conditions and / or their final use of the product.

ENGINEERED FLOORING EDGE GLUE FLOAT METHOD

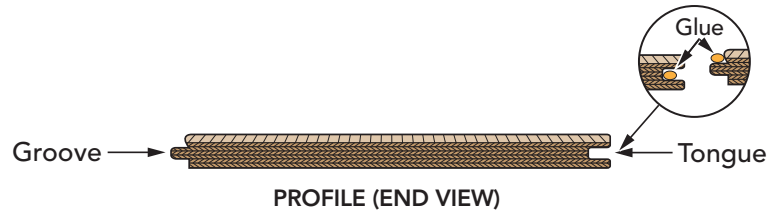

During installation, apply Exmore Tongue and Groove Adhesive (PVA Elastomeric glue) to each groove on the short and long sides of the planks to ensure bond with the other planks. Two separate continuous beads of glue should be applied: one continuous bead applied inside the groove, and one continuous bead applied to the top part of the tongue at joints to ensure a groove is securely bonded with the top and bottom of the tongue. This double gluing helps to minimize squeaks, board gaps, or separation.

GETTING STARTED:

Remove any existing quarter round, shoe moldings, baseboards and doorway transitions. Remove existing floor covering as required, check floor flatness per details on previous page and address any issues. Check that all doors will swing open with adequate clearance over the new flooring prior to starting any work.

Important: Do not cut metal door frames before first confirming it does not violate local building and fire codes. Any metal doors must be addressed by a specialist to adjust.

Undercut all door casings and jambs with a jamb saw to allow the flooring to slide under the doorjamb. If a baseboard is still in place, extend the undercut about 1" beyond the door frame casing. To find the height to cut the jamb, lay a scrap piece of flooring next to the door frame and lay the saw blade on top. After cut, ensure the floor plus underlayment does not bind, always leave 1/16" clearance under the door jamb / casing for the floor to be able to move freely without vertical restriction. **Check for alarm or other low voltage wiring before cutting.** Ensure that appliances have proper clearance to accommodate the new flooring.

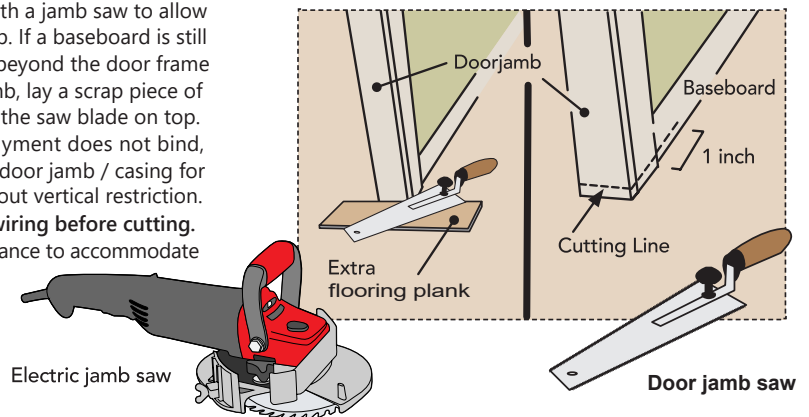

STEP 1:

Check that subfloor is flat to within specifications per details found under "CLEAN-DRY-FLAT" in previous section.

Correct any issues.

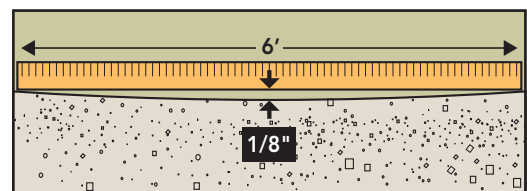

STEP 2:

Install 6 mil polyethylene film vapor barrier if subfloor is concrete or omit this step if an LL underlayment with a water vapor permeance of 0.1 perm or less when tested in accordance with the ASTM E96 is being used.

Never install 6 mil poly over wood substrates!

NOTE: Cushioned "vapor retarder" underlayments are not a substitute for a 6 mil polyethylene moisture barrier

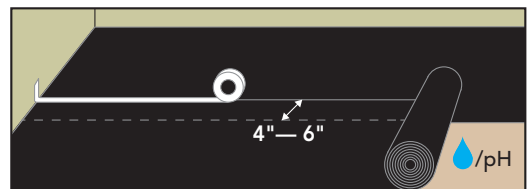

STEP 3:

Install customer preferred cushion.

Underlayment padding is highly recommended for flooring that does not come with a pre-attached cushion on the back of the plank.



STEP 4. LAYOUT:

- Determine which direction the planks will be installed. Generally, plank flooring is run parallel with the longest straight exterior wall, or the focal point of the room. Considerations are fireplaces, doors, cabinets, transitions. For best appearance full planks are desirable at the focal point and most cases it is the longest unbroken wall in the room.
- **Installers:** It is advisable to determine the installation layout and direction (North/South vs East/West) with the end user. Preparation of planks for the starting row when needed:

To avoid very narrow pieces at the finish wall; measure the distance between the starting wall and the finish wall, then divide this number by the width of the flooring planks. The fraction is the width of the last plank. If the width of the last row of planks will be less than 2-1/2" excluding the tongue, cut and adjust the width of first row of planks accordingly.

Preparation of planks for the starting row when needed:

To avoid very narrow pieces at finish wall, measure the distance between the starting wall to the finish wall, then divide this number by the width of the flooring planks. The fraction is the width of the last plank. If width of last plank is less than 2.5", balance by cutting (Rip) starting row of planks accordingly.

E.g. for a 12' room:

Start – Finish = 144" – 1" (1/2" expansion x 2) = 143" Width of plank = 5"

$143 \div 5 = 28.6$

Twenty eight full planks are required and last will be fraction x plank width.

$5" \times 0.6 = 3"$

If width of last plank is less than 2.5", balance by cutting (Rip) starting row of planks accordingly.

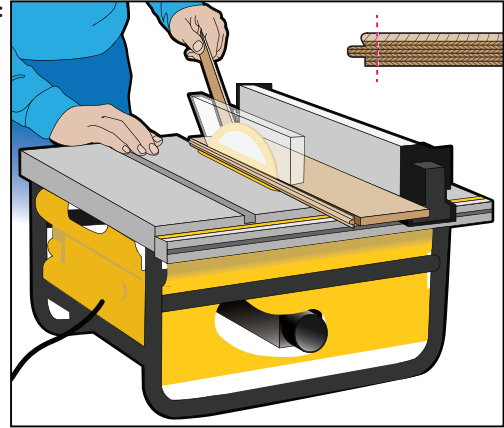

STEP 5. ESTABLISH A WORKING LINE

Start by snapping a chalk line parallel to your starting wall. The distance from the wall to the line will be the width of the plank used on first row plus the 1/2" expansion space. Use wedged spacers for a 1/2" expansion gap between the flooring and the walls. Place spacers adjacent to each plank joint, and at the beginning and end of each row. Be sure to keep a 1/2" gap around all vertical obstructions, e.g. newel posts, raised hearths, upright pipes or other fixtures.

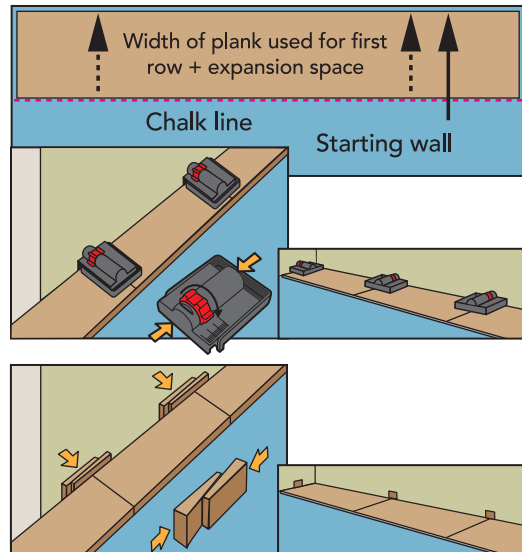

STEP 6. THE FIRST ROW

- Working left to right, lay the first plank against the wall (adjust spacers to ensure row lines up with your working line) using full length planks (the groove edge should follow along the working line). Continue laying the first row until you reach the other wall. Be sure to use Exmore Tongue and Groove adhesive or PVA wood glue on all long grooves on plank butt ends.

- When edge-gluing, ensure that the glue is still wet when the planks are joined. Special attention should be paid to ensure that there is no excess glue dripping to the subfloor as this could bond the plank to the underlayment and hamper floor movement. A lightly water dampened rag can also be used to remove any PVA glue.

Note: See Step 9 for cutting the last plank in row to fit.

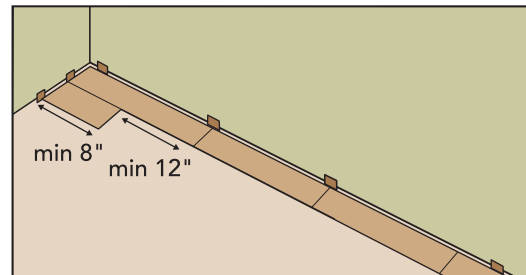

STEP 7. SECOND & CONSECUTIVE ROWS:

- Confirm the first row is straight with working line
- Progressively lay-in the next rows using "Edge-Glue-Float" method by inserting the tongue into the groove of the previous row at a slight angle
The last board in each row will need to be cut to fit (See STEP 9).
- The balance of the cut board may be used to start a new row if it is at least 8" in length.
- A tapping block can be used to gently tap the boards into proper position.
- During installation, minimize end gaps by temporarily locking-in each completed row with spacers (scrap flooring works for this) placed at the beginning and end of each row, remove when glue has dried.
- As you install, apply #2080 blue painters tape "stretched-tightly across plank surface perpendicular to the installed floor to hold planks together until adhesive fully cures.
- Remove all wet adhesive that gets on the floor right away!
NOTE: Incorrect tape can damage the floors finish!

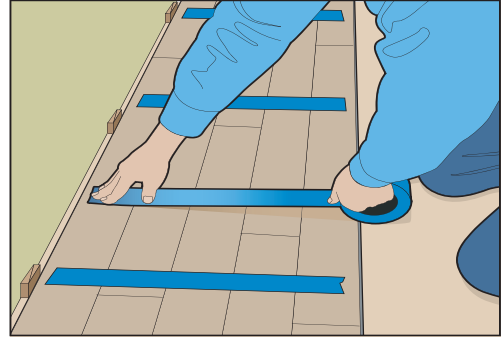

ALTERNATIVE METHOD:

Flooring straps may be used to keep planks reasonably tight, care should be taken not to over tighten the floor. Over-tightening may adversely affect floor and can re-sult in glue-bond failure, seam peaking, twisted boards or out of square flooring alignment.

Weights may be required to ensure adequate contact with the subfloor prior to adhesive setup.

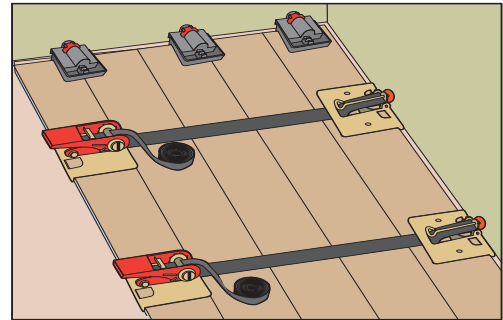

STEP 8. IMPORTANT

When laying planks, avoid starting or ending rows with cuts (short side) less than 8" in length. Stagger the end joints from row to row, by at least 8" to ensure the structural integrity of your floor and a pleasing appearance.

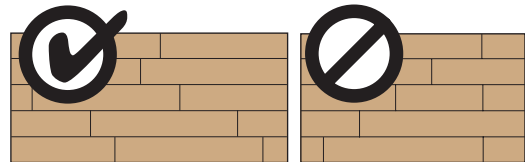

- Pull from several boxes to mix board color to create a random look.
- During installation, minimize end gaps by temporarily locking-in each completed row with spacers (scrap flooring works for this) placed at the beginning and end of each row, remove when glue has dried.
- Continue installing the flooring until you reach the opposite wall in the room.
- The last row may need to be "ripped-down" in width to fit (allow for expansion space). The last row should be glued and wedged with wood shims into place. Leave all spacers/shims in the expansion space until the adhesive has cured, then remove.

STEP 9. CUTTING END-OF-ROW BOARDS

The last board in each row must be cut to fit, while still maintaining a 1/2" expansion gap at the walls.

Here's how:

1. Measure from point of plank to wall spacer.
2. Mark plank to be cut using a square.
3. Cut the plank at the mark.
4. Install plank as normal.

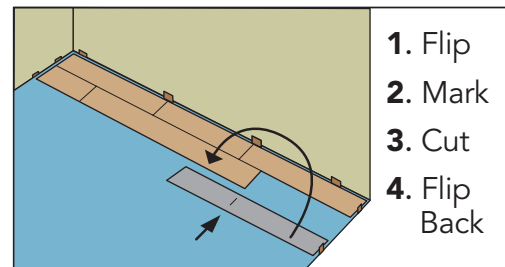

Power miter saw, table, circular and jig saws can be used to cut this flooring product.

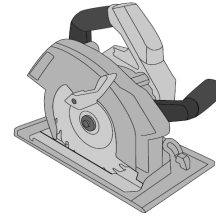
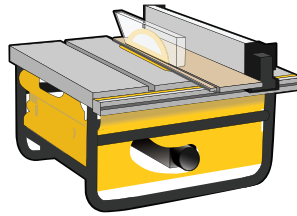

FITTING AROUND IRREGULAR SHAPED OBJECTS:

Make a template to fit around pipes or irregular shaped objects. Place the pattern upon the plank and trace. Cut along the trace lines using a jig saw, and install plank.

Note: Be sure to leave the recommended expansion space around all fixed objects, cabinetry and metal door jambs.

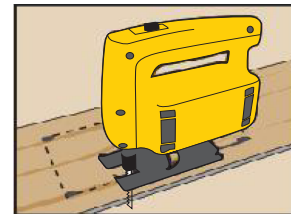

PIPES:

When a pipe is passing through the floor make a hole on the plank 1" greater than the diameter of the pipe, cut the plank with a 45° angle towards the hole. The cut-off pieceedges are glued in the position again. *Do not glue to the subfloor.*

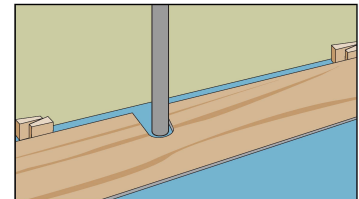
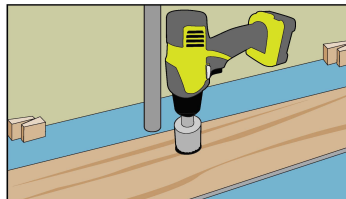

When there is single pipe on a wall, you can plan to have the end-joints meet at pipe, drill and install as shown.

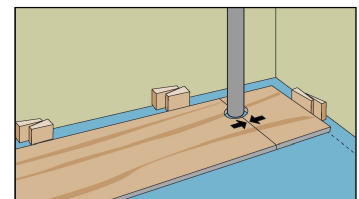
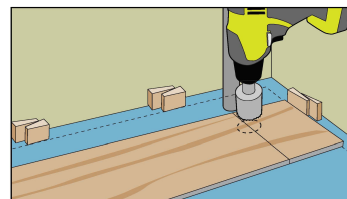
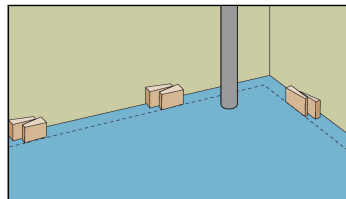

If there are multiple or larger pipes passing through the floor make hole(s) on the plank 1" greater than the diameter of the pipe, cut the plank with a 45° angle towards the hole. The cut-off pieceedges are glued in the position again. *Do not glue to the subfloor.*

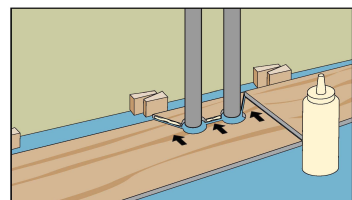
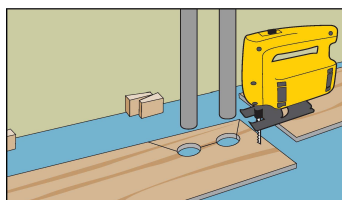
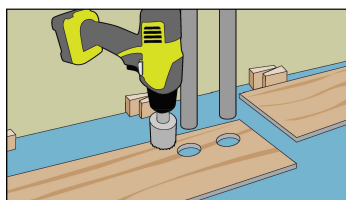

STEP 10. TRANSITIONS

In areas where your new floor meets other types of flooring, such as carpet or tile, select an appropriate molding to get a professional looking and safe transition.

Threshold moldings transition from floor to carpet and are used at sliding doors, raised hearths, etc.

Overlap Reducer moldings transition from floors to hard surfaces that are lower than the floor, such as vinyl or VCT tile.

Overlap Stair-nose moldings must be used for all "floating" installations. Example: when the flooring meets at the top of a stairway "going down".

T-Moldings cover expansion spaces at doorways, and they transition from your new floor to other hard surfaces of similar height.

3/4" Quarter Round moldings are used to cover expansion spaces between the baseboards and the flooring.

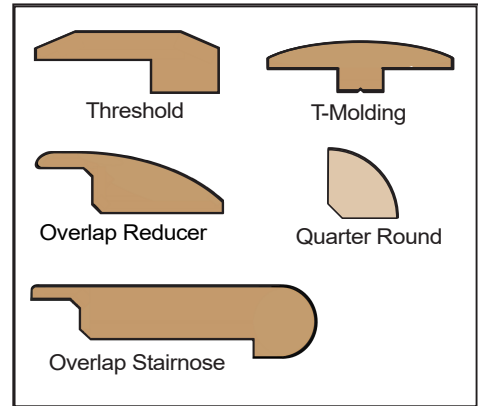

REPAIRS:

Save extra planks from the initial order in the event that installed planks become damaged and repairs are needed. This will ensure lot number and shading compatibility.

[HOME * WARRANTY * CARE](#)

CARE AND MAINTENANCE GUIDE

Engineered Wood Flooring is designed to bring beautiful wood looks to your environment to fit your flooring needs and style, while also providing a solution with easy maintenance.

Created for residential and light commercial applications, this flooring is tough but still requires care and attention to keep it looking beautiful for years to come.

- For day to day cleaning we recommend the floor to be swept and/or vacuumed. The vacuum head must be a felt brush type. Do not use vacuum with beater bars / very hard bristles. This will eliminate fine particles of dirt and grit that act like sandpaper which will scratch and / or dull the surface of your flooring.
- Reduce the visibility of minor scratches using Bellawood Scratch Away.
- Minimize abrasive material and dirt by placing mats on both sides of exterior doors and by using area rugs in high-traffic areas.
- Use Bellawood Floor Cleaner to deep clean your whole floor and clean spots and soiled areas.
- DO NOT use cleaning agents containing wax, oil or polish. Leftover residue will form a dull film.
- DO NOT use steel wool or scouring pad, as they will scratch the floor.
- DO NOT use steam or wet mops.

This flooring can be dented, gouged and scratched, this can be caused by but is not limited to: dropped objects, damaged shoe heels / soles, pet nails /claws, abrasive particles, etc.

The following steps will help reduce the risk of this kind of damage:

- Floor protectors should always be installed to the bottom of furniture to prevent scratching and marking.
- Minimize abrasive material and dirt by placing mats on both sides of exterior doors and by using area rugs in high-traffic areas.
- We recommend the use of a hard surface (non-studded), non-rubber chair mat to protect your floor from office chairs with casters.
- Light, rolling furniture should be outfitted with broad-surface, non-staining casters that have been engineered for hard surface floors (casters should be a minimum of 1" wide and at least 2" in diameter).
- Never slide or roll heavy furniture or appliances across the floor.
- If flooring will be exposed to rolling traffic or heavy, appliances protect the flooring with plywood or hard-board panels.
- Remove shoes that are damaged exposing sharp metal, have cleats etc. before walking on the floor.

As your floor ages, color change or "patina" can occur.

Whether finished or unfinished, all wood changes color over time due to oxidation and when exposed to UV light. Some species darken in color over time, while others tend to lighten. There is no known set value for "color fastness" of a species, so contractors and or customers should be aware of this normal condition. Certain species, including American cherry, Koa, Brazilian cherry, and many imported species, have this tendency to change in color. Some color change is to be expected for all species and a drastic change can be expected for some. This "Patina" process although normal, can be minimized by limiting exposure to direct sunlight or accelerated by exposure. Periodically moving furniture and rugs will help to equalize overall exposure to UV light. If possible avoid completely covering floors with rugs for the first six months.

Always promptly remove spills using a soft cloth reducing slip hazards.

We love our pets but occasionally accidents happen.

- Cleaning the affected area should begin immediately upon discovery:
- Use absorbent paper tissue to collect as much of the deposited material as possible and properly dispose of it. Remove any existing residue with a suitable disinfecting cleaner.
- Repeat until all residue is removed. Buff dry. Clean, using Bellawood Floor Cleaner.
- The more time that elapses before removal, the more difficult a stain will be to remove.
- Keep pets' nails trimmed.

We recommend the use of NON-RUBBER backed mats that are labeled "colorfast" by the manufacturer.

Non-staining, vinyl-backed mats or woven rugs should be used at all door entries from outside to avoid discoloration from asphalt driveways, catch dirt, grit, sand, and other debris to help sustain the flooring.

We also recommend using protective mats around sinks and tubs to catch excess water and debris.

Wall *

NAIL DOWN
[Method Click Here](#)

GLUE DOWN
[Method Click Here](#)

EDGE GLUE FLOAT
[Method Click Here](#)

INSTALLATION

Save time & avoid frustration! Please read these entire instructions before starting your installation, and A.I.M. for success!

AIM

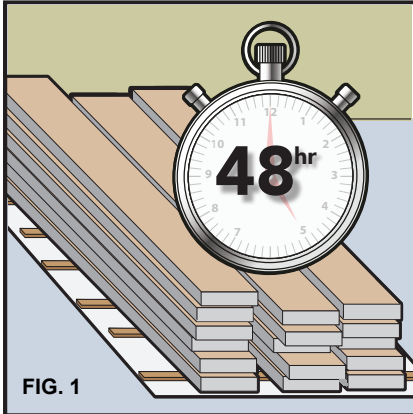

Acclimate Completely

Acclimate your flooring to your home environment. Time for acclimation will vary. Always check using a meter. Acclimation will ensure your flooring looks great for years to come

AIM



Install Correctly

Take time to review LL Flooring's installation guidelines and follow the National Wood Flooring Association Guidelines to ensure that your installation goes well from beginning to end.

AIM

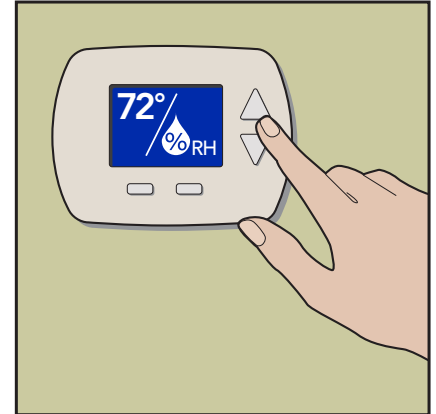

Maintain Environment

The ideal Relative Humidity (RH) range for Hardwood is 30%–50% at a temperature of 60°–80°F. It is acceptable in some households that this range may be higher or lower, but extreme fluctuations in RH must be avoided*.

*See Temperature and Relative Humidity for more details.



Need Help? To obtain installation assistance or product information concerning this flooring, contact the store of original purchase, or call the LL Flooring's customer care at 800-366-4204.



WARNING! DO NOT SAND, DRY SWEEP, DRY SCRAPE, DRILL, SAW, BEADBLAST OR MECHANICALLY CHIP OR PULVERIZE EXISTING RESILIENT FLOORING, BACKING, LINING FELT, ASPHALTIC "CUTBACK" ADHESIVES OR OTHER ADHESIVES.

These products may contain asbestos fibers and/or crystalline silica. Avoid creating dust. Inhalation of such dust is a cancer and respiratory tract hazard. Smoking by individuals exposed to asbestos fibers greatly increases the risk of serious bodily harm. Unless positively certain that the product to be removed is a non-asbestos containing material, you must presume it contains asbestos. Regulations may require that the material be tested to determine asbestos content. See current edition of the Resilient Floor Covering Institute (RFCI) publication, "Recommended Work Practices for Removal of Resilient Floor Coverings" for detailed information and instructions on removing all resilient covering structures. For current information, go to www.rfci.com.



LEAD WARNING: Some paints and finishes in homes built before 1978 may contain lead. Exposure to excessive amounts of lead dust presents a health hazard. Prior to removing or sanding, comply with all applicable federal, state, and local laws, and reference the publication "Lead-Based Paint: Guidelines for Hazard Identification and Abatement in Public and Indian Housing" available from the United States Department of Housing and Urban Development regarding (1) appropriate methods for identifying lead-based paint and removing such paint; and (2) any licensing, certification, and training requirements for persons performing lead abatement work.



MOLD AND MILDEW WARNING: Prior to removing an existing resilient floor or when installing a new floor, if there are visible indications of mold or mildew or the presence of a strong musty odor in the installation area, the source of the problem should be identified and corrected before proceeding with the flooring work. Excessive moisture in the subfloor could promote mold, mildew, and other moisture related issues like the trapping of moisture emissions under the flooring, which may contribute to an unhealthy indoor environment. Mold has the potential to cause health problems and may produce allergens, irritants, and in some cases, potentially toxic substances. Before installing the new resilient flooring, ensure the underlayment and/or subfloor is allowed to thoroughly dry and that any residual effect of excessive moisture, mold, or structural damage has been corrected. Remediation measures may require structural repairs such as replacing the contaminated underlayment and/or subfloor, cleanup measures using appropriate protection and biocide, or hiring a professional mold and mildew remediation contractor. Consult EPA mold guidelines on EPA's website at <https://www.epa.gov/mold>



WARNING:

Drilling, sawing, sanding or machining wood products can expose you to wood dust, a substance known to the State of California to cause cancer. Avoid inhaling wood dust or use a dust mask or other safeguards for personal protection. For more information go to www.P65Warnings.ca.gov/wood

This document covers wall applications using engineered wood flooring that have a plywood or lumber core only. Installation of your product should be in conformance with generally-accepted construction methods for interior wood-work per American National Standard ANSI/AWI 0620-2018 – *Finish Carpentry/Installation*.

RECOMMENDED USE:

- Residential or light commercial* interior use only. *See the product's limited warranty for details.
- **Install in good lighting.**
- **Do not install in exterior or wet areas. Do not install in boats, or other moving vehicles.**
- **Do not install directly to concrete or block walls.**
- **Walls need to be clean flat and dry.**
- **For safety and best performance: glue and nailing is required for all wall applications. These guidelines are for installation over conventional wood-framing with wall studs spaced no more than 24 inches on center.**

GRADE:

On, above and below grade.

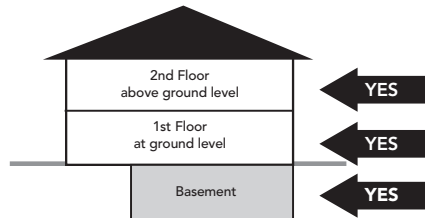

JOBSITE CONDITIONS:

- The building should be enclosed with all doors and windows in place.
- **Prior to delivery and install:** All wet works (e.g. drywall taping, texture, painting, stucco etc.) should be complete and allowed to dry. The rooms should be at normal “lived-in” conditions with HVAC operational for at least one week prior to the installation when home is so equipped.
- When installing in rooms over basements and garages, ensure they are dry and well ventilated.
- Crawlspace must be dry with a minimum 18” from the bottom of the floor joist to the ground, Crawl space earth (or thin concrete slab) should be covered 100 percent by a vapor retarder of black polyethylene (minimum 6 mil) or any recommended puncture-resistant membrane, such as Class C, meeting ASTM D1745. Ventilation shall be per local building codes.
- All gutters should be in place and functioning properly. Yard grading should be sloped to run water away from the home foundation.
- The installer – not the manufacturer or retailer – is responsible for making sure that the site conditions are appropriate prior to installation of this floor.

ACCLIMATION:

- Stack boxes no more than eight cartons high in areas to receive new flooring (remove plastic from outside of boxes if present). Ensure each layer is evenly supported to prevent distortion. Elevate stack using 2 x 4's as illustrated in Fig. 1 above. **On concrete; place a layer of 6 mil poly down first during the acclimation process.**
- Extended acclimation time should be anticipated and may be required. Time is not the determining factor; moisture testing is required to confirm that product is acclimated. Use a meter that is species adjustable, E.g. Ligno-scanner SDM or mini-Ligno DX/C moisture meter. If using alternate meter check with manufacturer that meter can be used with the wood species that you are installing.
- Check the moisture content of multiple planks. It's recommended to randomly test 40 planks for every 1000 square feet of flooring, the flooring's average moisture content must be within plus or minus 2% of the anticipated seasonally varying moisture content range for your geographical location (see Summer / Winter Moisture Map shown below) of wood-based products in the home (e.g. Base Board or Door Jambs) which must be dry and already within the anticipated equilibrium moisture content range for your geographical location..
- Keep a permanent record of all readings.

TEMPERATURE:

For best product performance, ensure the temperature in the home is between 60° and 80° F before, during, and after installation and for the life of the flooring.

RELATIVE HUMIDITY:

For best performance, flooring should be ideally conditioned, installed and maintained to consistent indoor temperatures of 60°- 80° F and relative humidity of 30% - 70% (not to exceed a 30% fluctuation in relative humidity, before, during and after the installation and for the life of the flooring. Ideal interior environmental conditions will vary from region to region and jobsite to jobsite, the relative humidity figures on your project maybe higher or lower.

The key is to ensure that the change in relative humidity stays within a 30% range (e.g.30% to 60% or 35% to 65% etc...) and does not fluctuate beyond 30% for sustained periods, enough to affect the flooring. Home environments where the relative humidity drops below 30% or exceeding 70% are not recommended.

Not following the written recommendations can negatively impact board performance and may result in excessive movement, squeaks, board gapping, board-edge cupping, cracks, twists, finish splits, flaking, chipping, fading and other related issues. Any home that may have a sustained change in relative humidity greater than 30% fluctuation needs an HVAC system equipped with a humidifier or dehumidifier to regulate the interior environment within a 30% range of fluctuation. Installing hardwood in an environment that is not maintained can be detrimental to the flooring.

The map below can be used to calculate what the optimum baseline or average moisture content of interior wood products should be prior to installation for each state and region. The first number indicates the average moisture content of wood during the wintertime (months having lower humidity), and the second number indicates the average moisture content during the summer time or (months having higher humidity).

To calculate the optimal baseline or average wood moisture content in your state or region, add the high season number and low season number together then divide by two. Example: If your state or region has an expected low of 6% to a high of 12% moisture content, the average baseline moisture content of the wood before installation would be 9%. The goal is to acclimate the flooring to this average figure and then the installation can begin.

Very dry or humid regions of the country usually require extended conditioning to balance the new flooring to the environment it will service.

The most reliable moisture-content numbers will be obtained using a species-specific moisture meter to determine the moisture content of the wood flooring. The USDA moisture map is a helpful guide for installations. Without proper temperature, humidity and ventilation controls, actual moisture content in any location may differ significantly from these numbers. In all cases it is the installer or homeowner's responsibility to determine if the indoor environment, moisture content and jobsite conditions are suitable for wood floor installations.

Summer / Winter Moisture Map

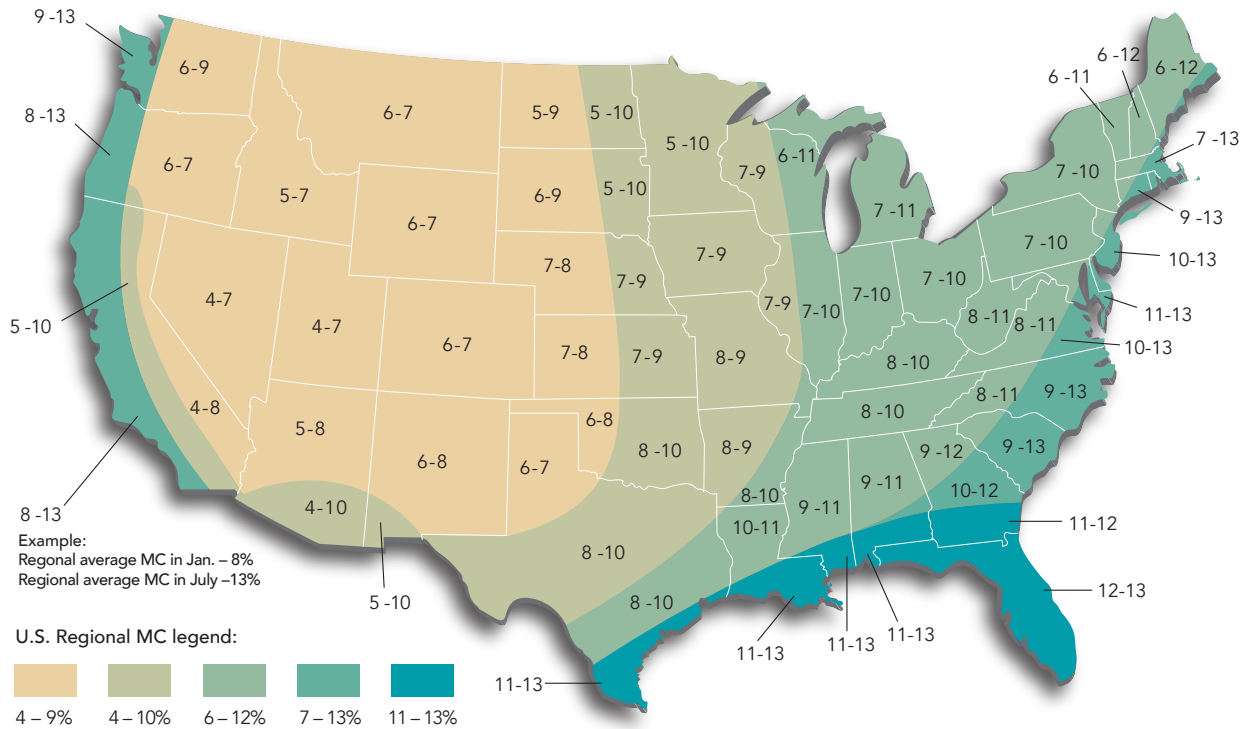

The effects of Temperatures and Humidity on wood flooring

Wood products are sensitive to moisture, temperature and humidity. Refer to the chart below to better understand the best in-home environmental relationship between relative humidity (RH) and temperature and its effects on wood moisture content. Determine the current temperature and RH within your home with a hygrometer. Find the combination of temperature and RH in your area on the chart (temperature variations are listed on the left side of the chart, humidity variations are listed along the bottom).

Example: The target or ideal moisture content for wood products is shown in the shaded area to be within 6.1% to 9.4%. Wood flooring will perform best when the interior environment is controlled to stay within a relative humidity range of 30% to 50% and a temperature range of 60° to 80° Fahrenheit. (In some geographical areas, the ideal humidity range might be higher or lower, 30% to 60% or 35% to 65% for example.) It is critical to maintain the relative humidity in your home to not fluctuate more than 30% at any given time of the year. Engineered Hardwood flooring installed in areas with a wider variation in RH (fluctuation in RH of more than 30%) can negatively impact board performance and may result in excessive movement (expansion / contraction, squeaks, board gapping, board-edge cupping, finish splits and other related issues).

Moisture Content of Wood at Various Temperatures and Relative Humidity Readings

°F	5	10	15	20	25	30	35	40	45	50	55	60	65	70	75	80	85	90	95	98
30	1.4	2.6	3.7	4.6	5.5	6.3	7.1	7.9	8.7	9.5	10.4	11.3	12.4	13.5	14.9	16.5	18.5	21.0	24.3	26.0
40	1.4	2.6	3.7	4.6	5.5	6.3	7.1	7.9	8.7	9.5	10.4	11.3	12.4	13.5	14.9	16.5	18.5	21.0	24.3	26.0
50	1.4	2.6	3.7	4.6	5.5	6.3	7.1	7.9	8.7	9.5	10.4	11.3	12.4	13.5	14.9	16.5	18.5	21.0	24.3	26.0
60	1.3	2.5	3.6	4.6	5.4	6.2	7.0	7.8	8.6	9.4	10.2	11.1	12.1	13.3	14.6	16.2	18.2	21.7	24.1	26.8
70	1.3	2.5	3.6	4.5	5.4	6.2	6.0	7.7	8.5	9.2	10.1	11.0	12.0	13.1	14.4	16.0	17.9	20.5	23.9	26.6
80	1.3	2.4	3.5	4.4	5.3	6.1	6.8	7.6	8.3	9.1	9.9	10.8	11.7	12.0	14.2	15.7	17.7	20.2	23.6	26.3
90	1.2	2.3	3.4	4.3	5.1	5.9	6.7	7.4	8.1	8.9	9.7	10.5	11.5	12.6	13.9	15.4	17.3	19.8	23.3	26.0
100	1.2	2.3	3.3	4.2	5.0	5.8	6.5	7.2	7.9	8.7	9.5	10.3	11.2	12.3	13.6	15.1	17.0	19.5	22.9	25.6

CUTTING ALLOWANCE and MANUFACTURER TOLERANCE (waste factor):

A 10' x 10' room has net 100 square feet (Sq. Ft.) – the actual area that will have flooring – but more product is required to allow for cutting which generates unusable pieces.

Carefully measure the net square feet required, adding up multiple areas.

The table gives an approximate recommendation for cutting allowance: Quantities are always rounded up to the nearest box.

Note: Engineered Natural products generally have a 5% manufacturer tolerance which should be added to the Cutting allowance. If defects are greater than the waste factor indicated for your flooring, please contact your local store or call Customer Care at 1-800-366-4204.

Tip: If more than half a box is not available for spares we recommend ordering an extra box.

Please note: Actual cutting waste may be lower or higher based on room layout. E.g. multiple rooms vs. one large area and "pattern" being installed.

Consider carefully before returning boxes. Keeping extra boxes is a great idea and inexpensive insurance against damage, if a repair is needed the product and batch will be the same, and you have options even if the product has been discontinued.

Diagonal installations may require 5% extra material over and above the cutting and manufacturer tolerance allowance.

Net Area SqFt	Total with Cutting Allowance SqFt	% Applied
100	110	10
200	218	9
400	432	8
600	642	7
800	848	6
1000	1050	5
above 1000 SqFt add 5%		

EXPANSION SPACE:

1/2" is required top and bottom of the wall and both inside corners (sides).

RUN WIDTH AND HEIGHT:

Height - 10' maximum.

Width - No maximum when installed correctly (When installed as Vertical Wainscot Style, runs greater than 20 L. F. may require "Dime Rows" Tongue and groove only).

SUNLIGHT:

Depending on the species, your flooring will naturally change color "patina" with prolonged exposure to sunlight. Use of window coverings, shades, or tinting your windows is recommended to slow this natural process.

CABINETS AND FIXTURES:

Flooring used as Wall Cladding is not a structural material. Do not fasten cabinets or fixtures to the flooring used as decorative wall covering.

SURFACE PREPARATION:

- All substrates must be structurally sound, dry, solid and stable.
- The substrate should be clean and free of dust, dirt, oil, grease, wax, soap, existing adhesives and adhesive residues, and any other substance that may prevent, reduce adhesion or affect product performance. Sponge wash with TSP (tri-sodium phosphate), to remove residues of greasy grime, mildew, chalked paint or anything that might affect the adhesive bond.
- Walls must be plumb and flat to 3/16" in 6'.
- All surfaces must be smooth and free of defects, voids, deviations, imperfections and irregularities. If the wall has a heavy drywall texture, it will need to be block sanded or skim coated and primed.
- Countersink any protruding screws. Use an appropriate patching compound to cover screw heads and correct any holes, bumps, cracks, depressions, etc.

Prime or paint as needed.

Do not install over substrates that have water damage, visible water stains or leaking windows. Remove protruding nails.

USER / OWNER / INSTALLER RESPONSIBILITIES:

- These recommendations do not pertain to the suitability of products used as interior finishes on walls with regards to fire, flame spread, smoke, or any other related flammability characteristics. Care should be taken to ensure that any installation of products on walls meets all applicable federal, state/ provincial and local codes as well as other requirements.
- Product installation constitutes acceptance. Visually inspect the product and determine acceptability before installation. Claims will not be accepted regarding visual defects after the flooring has been installed. If any planks are unacceptable due to color, finish, milling or any other reason, it is your responsibility to determine to use them, hide them in areas like closets, trim off the imperfection, or not install them at all.
- A reasonable amount of installed product (up to 25% or 100 sq. ft. whichever is less) is enough to determine acceptance of quality.
- Retain a box label and keep on file with your receipt for future reference.
- If quality issues are suspected stop the installation and call your local store or CUSTOMER CARE at 800-366-4204.

HELPFUL TOOLS: (as needed)

- Tape Measure • Pencil • Chalk line • Stud Finder • 6' level • Miter saw • Table saw • 60 tooth carbide tip saw blade • Drill + Drill bits • 18 Gauge Brad Nailer • 1 1/2" - 1 3/4" Brad Nails • Compressor with regulator • Hammer • Flat Pry Bar • Rubber Mallet • Hygrometer (to monitor in-home humidity) • Species adjustable Moisture meter (wood) • Caulk Gun • Urethane Construction Adhesive • Step Ladder • Screw Drivers • Eye protection • Ear protection • Niosh Dust Mask • Gloves • Color Putty • Cloth rags • Color Putty • Touch up markers

GETTING STARTED:

Step 1: Preparation

- Turn off power while working around wall outlets and light switches
- Remove existing wall base, trim, electrical cover plates, HVAC vent/return covers thermostats, etc., prior to installation.

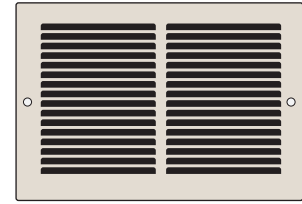
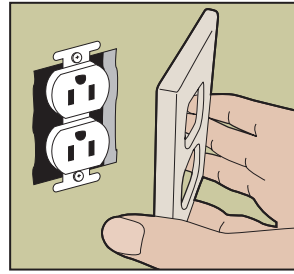
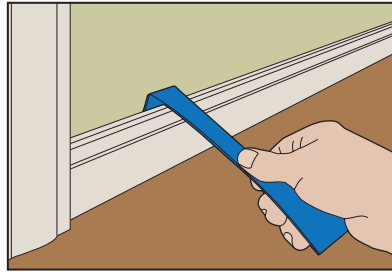

Installation over drywall

- Use a 6' level or straight edge to insure the wall is flat in both directions.
- Walls need to be flat to within 3/16" in 6'.
- Correct any unevenness using a drywall joint compound.

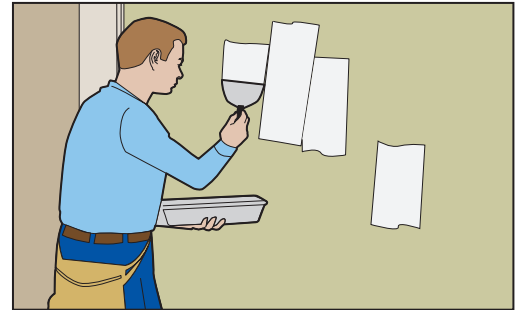
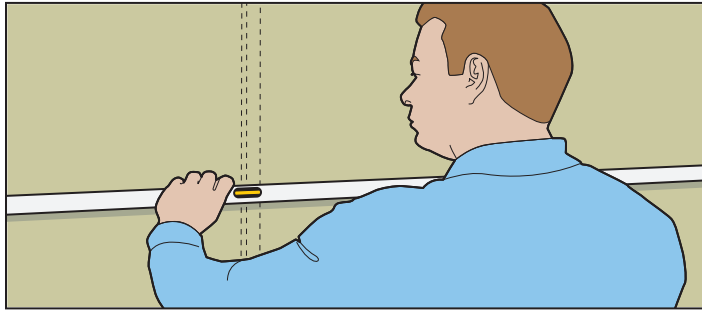

- Make repairs and remove any loose paint, wallpaper and all other contaminants that may affect adhesive bond (prime & paint repaired areas).

Step 2: Identify and Mark Stud location

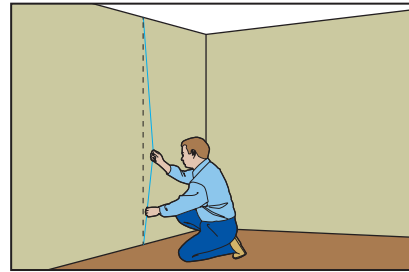
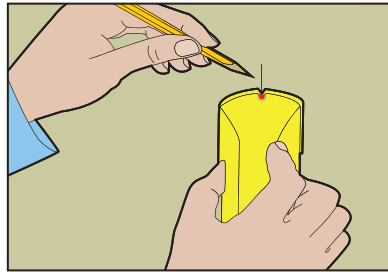

- Using a stud finder to identify studs, mark top and bottom of studs using a pencil.

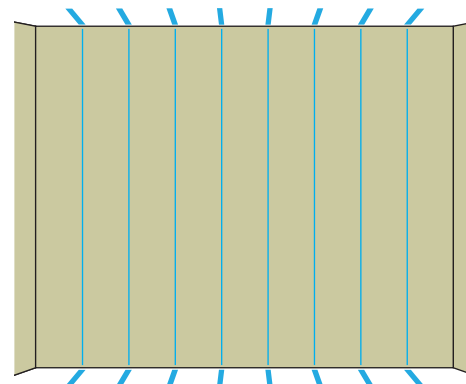
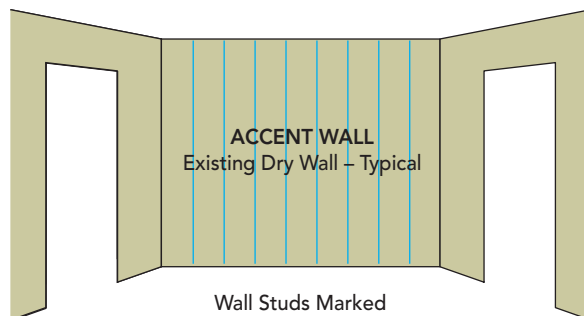

- Using a chalk line stretched between bottom and top mark, snap a line. Use painters tape at top & bottom of **each** stud on floor and ceiling to identify nailing points.

Step 3: Establishing your starting line

Establish a working line on your feature wall by **measuring up** from the floor and at equal distances (approx. 12") from each corner of the wall. The distance from the floor to the line will be the width of the first row of planks used plus the minimum 1/2" expansion space.

- Mark these points on wall and snap a chalk line (as shown) parallel to the floor.
- Check that line is level in case of uneven floors.

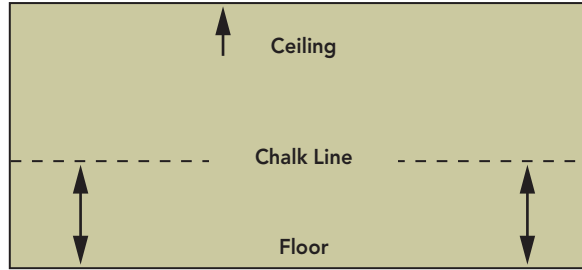

Preparation of planks for the starting row:

Rack Out. It is recommended that the planks are laid out on the floor prior to installing, this will give opportunity to remove unsatisfactory planks and ensure a pleasing layout prior to fixing in place.

To avoid very narrow pieces at the ceiling; measure the distance between the floor and the ceiling, then divide this number by the width of the flooring planks. The fraction is the width of the last plank. Eg. for standard 8' wall:

$$\text{Floor} - \text{Ceiling} = 96" - 1" \text{ (1/2" expansion x 2)} = 95"$$

$$\text{Width of Plank} = 4"$$

$$95 \div 4 = 23.75$$

Twenty three full planks are required and last will be fraction x plank

$$\text{width } 4" \times 0.75 = 3"$$

If width of last plank is less than 2.5", balance by cutting (Rip) bottom row of planks accordingly.

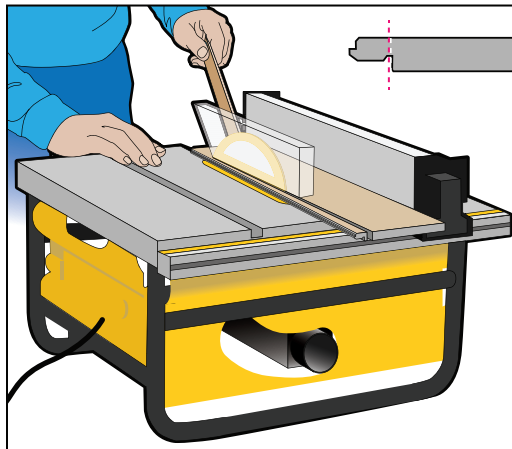

Board orientation

- Begin the first row with the groove facing up. **Install Right to Left.**

Step 4. FIRST ROW:

Glue and Fasten: Use 1-1/4"- 1-3/4" 18 - 20 Gauge finish nails to secure to wall studs. Nails shall penetrate a minimum of 3/4 inch into studs spaced no more than 24 inches apart. Each plank in the first row shall be fastened with two nails into a stud and bottom plate (as shown below). Each plank shall be long enough to be attached to at least two studs.

- Use wedged spacers for a 1/2" minimum expansion gap between the subflooring and the first row. Place spacers adjacent to each plank joint.

IMPORTANT: adjust to keep line perfectly straight to your starting line!

Apply a 1/4" bead of Bostik Tread-Lock adhesive in a serpentine pattern on the back of each plank as installed.

- Place the plank on top of the spacers making sure top of plank is on the chalk line, leaving a minimum 1/2" expansion space at starting end wall.
- Be sure that there is an adequate transfer of adhesive transfer to the wall using a slight back and forth motion and firmly pressing the entire plank against the wall.

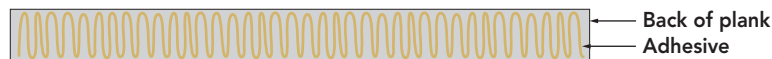

Blind Nail and face nail this row as shown . Tip: product may install left to right

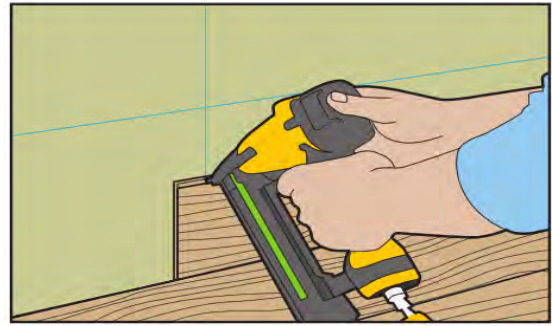
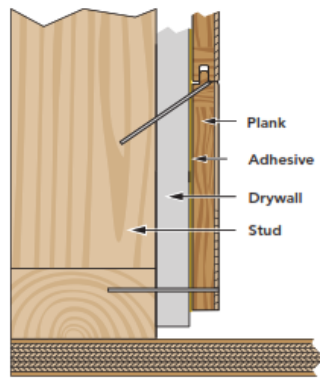

Use a level to double-check the levelness of the line between the two marks. Adjust line as needed with spacers. Secure this first row fully using adhesive and 2" finish nails or wood screws into pre-marked wall studs, placed approximately 2" above subfloor (these will be covered by your baseboard trim).

Using a finish nailer, nail at an angle into the groove of the plank to secure the plank to the wall studs. All nails should be counter-sunk so it does not interfere with the next plank. Continue with this method until you have completed the row.

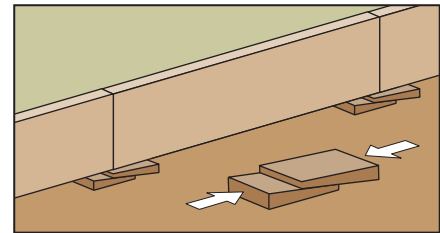
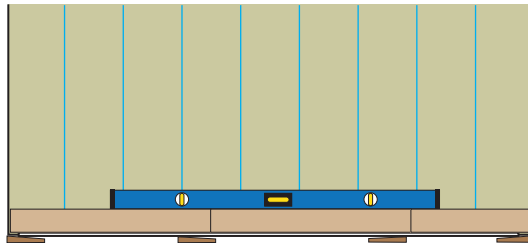

CUTTING END-OF-ROW BOARDS:

The last board in each row must be cut to fit, while still maintaining a 1/2" expansion gap at the walls. Here's how:

1. Measure distance from last installed plank to end of wall.
2. Transfer this measurement (less 1/2") to plank you will cutting and mark it on the face.
3. Cut the plank at the mark.
4. Install as normal.

Using a finish nailer, nail at an angle into the groove of the plank to secure the plank to the wall studs. All nails should be counter-sunk so it does not interfere with the next plank. Continue with this method until you have completed the row.

IMPORTANT:

When laying planks, stagger the end joints from row too row by at least 12" to ensure the structural integrity of your wall and a pleasing appearance. Pay close attention to avoid "stair step" or "H-patterns" appearing in the flooring.

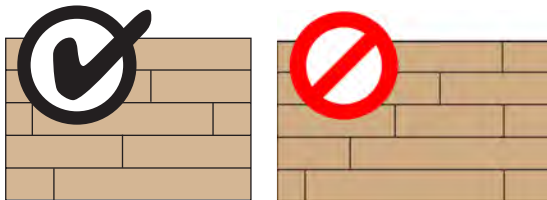

Step 5: SECOND & CONSECUTIVE ROWS:

For best results, lay out planks on the floor to select placement of each plank. This will allow the proper mix of colors, patterns, etc... Continue using adhesive and blind nailing each plank as detailed in Step 4. Above.

- Working right to left, place the planks on top of previous row leaving a minimum 1/2" expansion space at starting and end walls. Using a finish nailer, nail at an angle into the groove of the plank to secure the plank to the wall studs. All nails should be counter-sunk so it does not interfere with the next plank. Continue with this method until you have installed the last full plank. **Fasteners should be long enough to penetrate a minimum of 3/4" into wall studs.**

Continue with this method until you have installed the last full row. Tip: product may install left to right

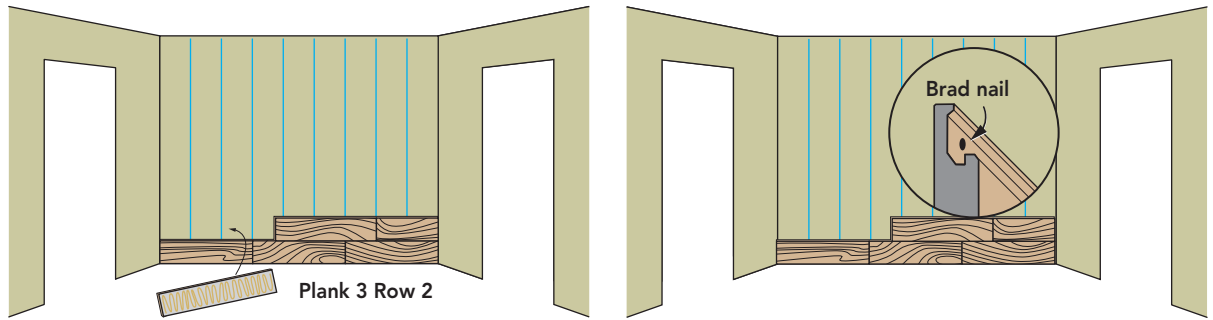

CUTTING AROUND FIXTURES:

Measure and mark planks to fit around any existing outlets, switches, vents, etc.

Outlet "Box Extenders"

An electrical box extension shall be used as required by local building codes, to bring the switches and receptacles flush with the laminate.

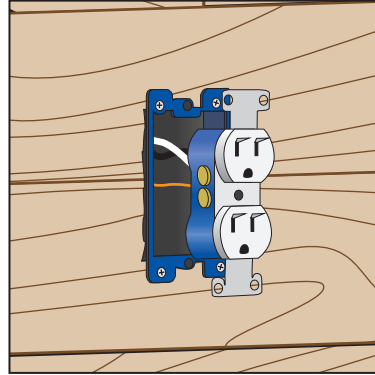

Do not cover receptacle retaining screw /surrounding fixture, to allow for bringing receptacle forward to accommodate for the thickness of new planks.

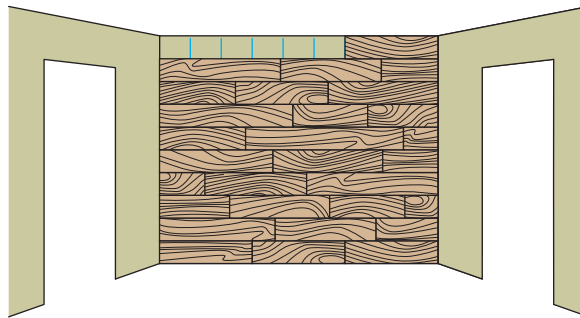

- The last row will need to be cut lengthwise (ripped down) to fit properly to the ceiling, leaving a minimum 1/2" for expansion.

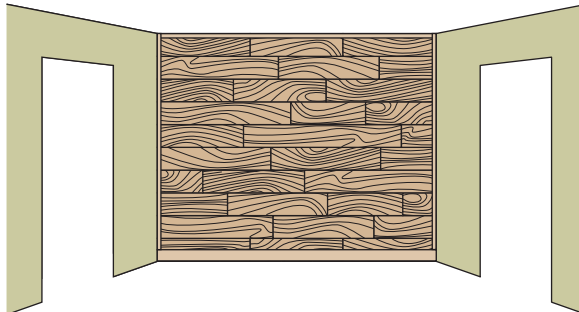

- Pre-drill and finish nail last row(s) as needed.

Vertical Wainscot Style

Glue and Fasten: Nails shall penetrate a minimum of 3/4 inch into bottom plate and studs. Each plank shall be fastened with two nails into the bottom plate.

- Use wedged spacers for a 1/2" minimum expansion gap between the subflooring and the first row.

Place spacers adjacent to each plank joint.

IMPORTANT: adjust to keep line perfectly straight to your starting line!

Apply a 1/4" bead of Bostik Tread-Lock adhesive in a serpentine pattern on the back of each plank as installed.

- Place the first plank vertically on top of the spacers and check it is plumb using a level, leaving a minimum 1/2" expansion space at starting end wall.
- Be sure that there is an adequate transfer of adhesive transfer to the wall using a slight back and forth motion and firmly pressing the entire plank against the wall.

Continue with installation. When a stud is overlapped by a plank use 1-3/4" 18 Gauge finish nail to secure to wall stud. These nails should be positioned so the final trim piece covers them.

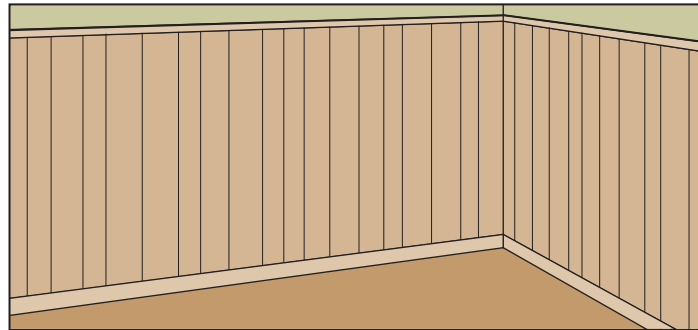

- Determine how many planks will be needed to fill the wall. For the best overall appearance, the first and last planks should be the same width.
- Measure to the appropriate height where you would like to stop the wainscot, plus 1/2" expansion space. Chalk a line between the two walls.

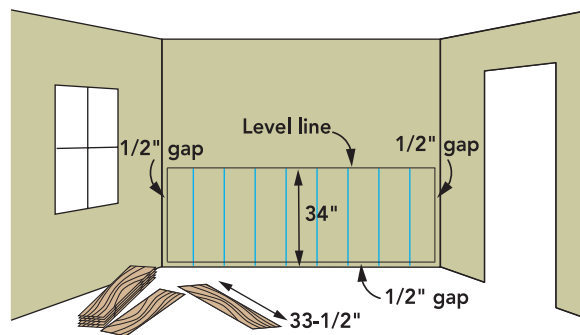

- Cut planks to fit to top chalk line.
- Apply a 1/4" bead of adhesive in a serpentine pattern on the back of the plank.

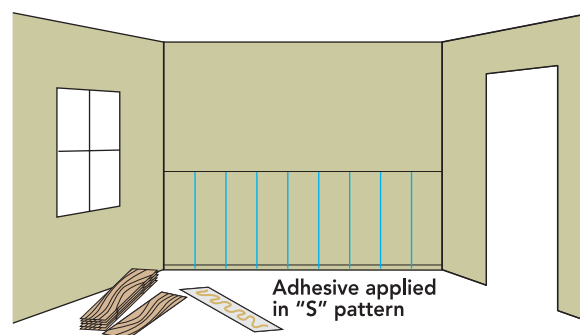

- Set plank in place with the top of the plank on the chalk line leaving a minimum 1/2" expansion space at bottom of wall.

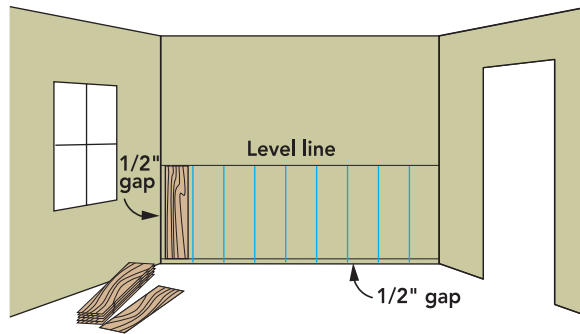

- Continue installation of the following rows using the same method as above.
- Fasten planks using adhesive and nail schedule described above.

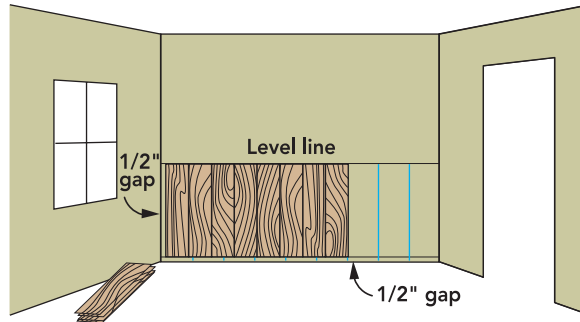

- The last row will need to be cut lengthwise to fit properly, leaving a 1/2" for expansion.

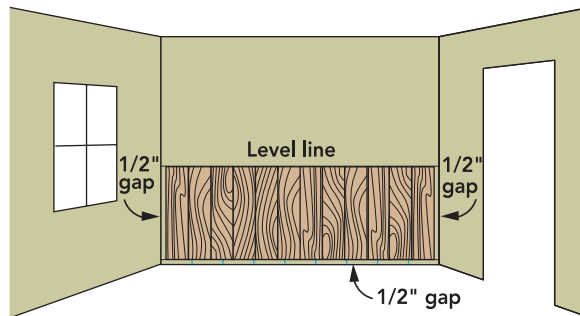

Trim out walls using 3/4" round (avoid nailing into planks).
Install baseboard to cover gap along floor and Install threshold along top edge to finish wainscot wall.

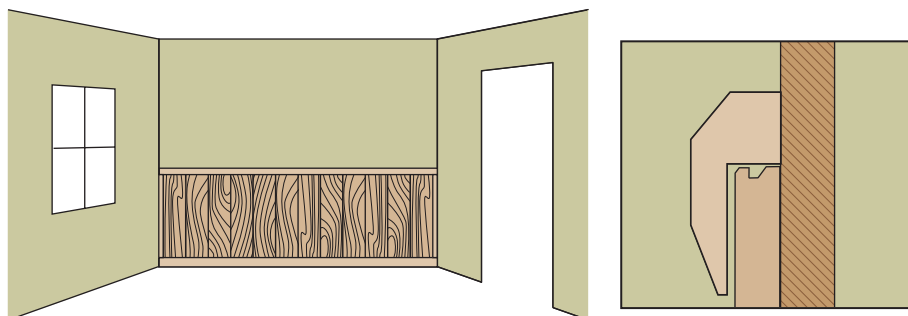

Step 5 Finishing up — ALL METHODS:

- Install the desired moldings to hide perimeter expansion gaps.
- Install electrical switch plates.
- *An electrical box extension may be needed to bring the switches flush to the finished wood.
- All electrical connections should be performed by a licensed electrician.

Applications

Base Board – for hiding imperfections and adding a custom finish along any wall.

Quarter-Round - for covering the expansion left at walls and other fixed surfaces.

Reducer Moldings - used to transition to lower surface.

End Cap - for finishing the space at sliding glass doors, at bath tubs or transitioning to carpet.

CAUTIONS:

CABINETS AND FIXTURES:

Flooring is not a structural material. Do not fasten cabinets or fixtures to the flooring used as a decorative wall covering.

Do not attach objects such as sconces, shelves or mount televisions directly to the wall or use nails in the wall for hanging objects. Instead, drill pilot holes and mount objects directly to wall studs with screws.

Wall Sconces (lighting):

Do not exceed the maximum recommended wattage of the light fixture.

[HOME * WARRANTY * INSTALLATION](#)

LIMITED COMMERCIAL WARRANTY

Builders Pride - Virginia Millworks - Mayflower Engineered Hardwood Flooring Products

For Residential Limited Warranty [click here](#)

1. WHO MAY USE THIS LIMITED WARRANTY?

LL Flooring, Inc. (“we,” “us,” and “our”) extends this limited warranty only to the customer who originally purchased the product (“you” and “your”). It does not extend to any subsequent owner or other transferee of the product. **THIS LIMITED WARRANTY IS NOT TRANSFERABLE. THE LIMITED WARRANTY EXTENDS ONLY TO THE ORIGINAL PURCHASER.**

2. LIGHT AND HEAVY COMMERCIAL USES AND THE PERIOD OF COVERAGE

- *Light Commercial*

Our products are designed for commercial and business uses. The limited warranty periods for each product are determined by their application and use. Light commercial uses are defined as areas where foot traffic is light to moderate and light to moderate castor chair use where castors are modified using caster chair wheels (soft wide castors specifically for hard surface) or castor chairs are used with castor chair mats designed for hard surface and without the use of heavy chemicals, acids, greases, or other such contaminants. Examples of light commercial uses include: professional offices, including lobbies, waiting rooms, hallways; corporate locations such as banks, conference rooms, meeting rooms; small retail stores such as salons, jewelry stores, dressing rooms; applications in apartment lobbies and common areas, and connecting hallways and offices.

- *Heavy Commercial*

Heavy (or Full) Commercial Areas are areas of use with floors subjected to, moderate to heavy foot traffic and moderate to heavy castor chair use where modified caster chair wheels (soft wide castors specifically for hard surface) or castor chairs are used with castor chair mats, designed for hard surface moderate to heavy traffic. Portable furnishings with casters, rests and hard wheels that concentrate the weight or point loading of the appliance/equipment are excessive heavy use.

- *Determination of Application and Use*

We shall have the sole right to make the determination of whether an application is for light or heavy commercial uses. For purposes of such determination, we may need to visit the location that relates to the warranty claim for inspection and use. **These limited warranties do not apply to excessive heavy use or industrial uses. Industrial uses include but are not limited to use in environments with heavy chemicals, acids, greases (including for food) or other such contaminants, and those use in environments with forklift use, industrial plants, uses where extra heavy static and dynamic loads are applied to flooring, and use of casters bearing extra heavy loads on resilient flooring.**

Subject to the requirements listed in Section 5 below, this limited warranty starts on the date of your purchase and lasts for the time period set forth in the chart below for your specific product (the “Limited Warranty Period”):

Product Identification	Limited Light Commercial Warranty Period
Builders Pride	5 Years
Virginia Mill Works	5 Years
Mayflower	N/A

If, for any reason, we repair or replace the product, the Limited Warranty Period is not extended. We may change the availability and duration of this limited warranty at our discretion, but any changes will not be retroactive, and shall only apply to products purchased after such changes.

3. WHAT DOES THIS LIMITED WARRANTY COVER?

During the Limited Warranty Period and subject to the complete terms of this limited warranty, this limited warranty covers the following product aspects from defects in materials and workmanship of the purchased product (the “product”):

- *Limited Finish Wear Warranty.* Finish wear from normal use conditions resulting in the exposure of the bare wood or bamboo, subject to the exclusions provided in Section 4 below.
- *Defects Included in Waste Factor.* Manufacturing and natural defects in excess of the Waste Factor (defined below). For purposes of this limited warranty, “Waste Factor” shall mean the allowance for manufacturing and natural defects in flooring and is represented by a percentage—namely, that: (i) no more than 5% of the total square footage of your purchase of 1st-grade, 2nd-grade, natural, select, and clear grade products; (ii) no more than 20% of the total square footage of your purchase for 3rd-grade, common, rustic, mill run, and mixed-grade; (iii) no more than 25% of the total square footage of your purchase of cabin grade, tavern grade, and utility grade products. For purposes of clarity, the Waste Factor does not relate to product waste caused by your cutting the product for your intended project or use. Rather, the Waste Factor relates to the stated percentage of the product as purchased that a purchaser can expect to have manufacturing or natural defects. Your cutting allowance (that is, the inherent waste created by your cutting the product) is not a defect or deficiency and will depend on your project and your use of the materials.
- *Delamination.* The product will not delaminate under normal use conditions.

4. WHAT DOES THIS LIMITED WARRANTY NOT COVER?

This limited warranty does not cover any defects or damages due to: (a) failure to strictly follow the Installation and Care Requirements (defined and discussed below) regardless of the installer; (b) transportation; (c) storage; (d) improper use; (e) modifications; (f) unauthorized repair; or (g) external causes such as accidents, abuse, or other actions or events beyond our reasonable control. In addition, this limited warranty does not cover any defects or damages due to the following:

- *Moisture (or Lack of Moisture).* Damages caused by moisture (such as leaking pipes, spills, wet mopping, pets, relative humidity, subfloor moisture etc.) are excluded. Moisture (and

dryness) can cause issues such as checks, cupping, crowning, warping, buckling, peeling, twisting, seam swelling or gapping. In addition, moisture intrusions from concrete hydrostatic pressure, flooding, or plumbing leaks, along with high levels of alkalinity, can affect flooring and subflooring over time and moisture can be trapped below the flooring and/or underlayment and create mildew or mold. Damage from such conditions, including to the floor and subfloor, is not covered under this limited warranty.

- *Site and Environmental Conditions.* Defects or damages resulting from: site conditions (such as extreme heat, radiant heat (for some products), or exposure to sand); indentations and scratches (caused by furniture, heavy rolling loads like un-modified wheels on caster chairs, castor chairs without protection mats, heavy electric wheel chairs, metal or thin wheels on appliances, tools, grit, heels, pets nails and claws, toys, etc.); improper maintenance and accidents; misuse and abuse. These items are not covered under this limited warranty
- *Within Waste Factor.* Defects in flooring that do not exceed the Waste Factor (defined above) are not covered under this limited warranty. Consequently, it is recommended that you add the applicable percentage to your total square footage when ordering your floor.
- *Other Finishes.* This limited warranty covers the factory-applied finish only. Applying another finish or sanding (such as in preparation for another finish) may damage the factory-applied finish and voids this limited warranty against finish wear.
- *Exterior/Outdoor Installations/Use.* This limited warranty does not cover exterior, outdoor, partial outdoor installations / use of the product.
- *Non-Flooring Installations.* This limited warranty does not cover use of the products for installations on ceilings or other usages for purposes other than flooring (like furniture or countertops).
- *Visible Defects.* As discussed further below in Section 5.C., products installed with visible defects are not covered under this limited warranty. Accordingly, before installation, you and the installer should examine each product to ensure it is satisfactory.
- *Natural Characteristics.* Wood and bamboo are natural products. They may change as a result of the conditions to which they are exposed including seasonal and environmental factors. Color changes due to aging or exposure to UV/sunlight may also occur. In addition, natural variations from board to board, like differences in grain, color, tone, and knots, may exist.
- *Expansion and Contraction.* As a product of nature, wood and bamboo react to changes in temperature and humidity. Small gaps between planks are a normal occurrence with changes in relative humidity. These gaps are seasonal and show up primarily in the winter when cold temperatures lower the relative humidity in the air. Engineered wood and bamboo flooring perform best at relative humidity rates between 30% and 70% and temperatures between 60°F and 80°F (not to exceed a 30% fluctuation in relative

humidity), before, during and after the installation and remain at such levels throughout the life of your floor to ensure optimum performance. Please note that ideal interior environmental conditions will vary from region to region and jobsite to jobsite, the relative humidity figures on your project maybe higher or lower. You must ensure that the change in relative humidity stays within a 30% range (e.g.,30% to 60%) and does not fluctuate beyond 30% for sustained periods, which may affect the flooring. Environments where the relative humidity drops below 30% or above 70% are not recommended or subject to coverage under this limited warranty. Leaving a building/structure unoccupied without climate control for extended periods of time can lead to damage to the floor from excessive humidity build-up or extremely dry conditions. Both scenarios can damage the floor, cabinets, and furniture.

- *Color and Shade Variations.* New or replacement flooring may not always match samples, printed color photography (including websites and catalogs), existing flooring or other products (such as cabinets, stair railings, trim and moldings) due to, among other things, natural variations that occur in species, age, growing conditions, exposure to UV/sunlight and other factors. These variations should be expected. Inspect product before installation claims for color and shade variation will not be accepted after the product is installed.
- *Discoloration/Fading from Mats.* This limited warranty does not cover discoloration due to use of rubber-backed mats or other incompatible mats.
- *Odd Lots or AS-IS.* An odd lot (or flooring sold AS-IS) is flooring that is discounted because it did not pass our rigorous inspection process and is not covered by this limited warranty.
- *Third-Party Purchases.* Except for an authorized transfer in writing by us, this limited warranty does not cover any purchases other than those made directly from LL Flooring in store, online, or by phone.
- *Radiant Heat.* Please consult the Installation and Care Requirements regarding whether your product may be installed over radiant heat. If your Installation and Care Requirements do not include materials regarding installation over radiant heat, your product is not appropriate for installation over radiant heat and not covered under this limited warranty for such installations. If your Installation and Care Requirements provide instructions for such installation, this limited warranty does not cover those products that are not installed according to the radiant heat manufacturer guidelines or not installed in compliance with the Installation and Care Requirements.
- *Removal and Replacement.* This limited warranty does not cover the cost of the removal or replacement of countertops, cabinets, built-in appliances, or other fixtures, installed on top of your floor.
- *Improper Installation and Maintenance.* This limited warranty does not cover any dissatisfaction or damage due to improper installation or maintenance (but excluding improper installation or maintenance performed by us). This includes any damages caused

by any installation (regardless of the source of the installation advice other than directly provided by us) that conflicts with the applicable product installation instructions—for example, damage caused by sub-surface, sub-flooring and jobsite environmental deficiencies, improper transportation, acclimation, and storage.

5. HOW DO I MAINTAIN THIS LIMITED WARRANTY DURING THE LIMITED WARRANTY PERIOD?

To maintain this limited warranty during the Limited Warranty Period, you are obligated to meet all of the following requirements for your use, installation, and maintenance of the product (the “Installation and Care Requirements”). The Installation and Care Requirements must be strictly followed for the limited warranty to remain valid and not be void.

- A. *Follow the Pre-Installation Requirements.* Prior to installing a single board, tile, or product, you or the installer must determine that the job-site environment and the sub-surfaces (including subfloor substrates) meet or exceed applicable industry and product standards, including, without limitation, moisture testing and controls. The product installation instructions discuss these standards and are provided in full below. These requirements must be strictly followed.
- B. *Comply with All Laws.* In your installation, maintenance, and use of the product you must comply with all laws and regulations, including, without limitation, all applicable environmental and building codes, regulations, and laws.
- C. *Inspect All Products for Visible Defects.* Products installed with visible defects are not covered under this limited warranty. Accordingly, before installation, you and the installer should examine each product to ensure it is satisfactory. If any products are unacceptable for any reason, it is up to you to determine to use them, , trim off the imperfection, or not install them at all. You should plan on being present during your installation to ensure that all required procedures are completed and products with visible defects are not installed. It is important to inspect individual boards and tiles and to frequently step back to observe the “whole picture” before installation is completed. *If quality issues are suspected before or during installation immediately contact the store where your floor was purchased or call us at 1-800-366-4204.*
- D. *Follow the Installation and Care Instructions.* It is your duty to make sure the installation requirements are strictly followed, including, without limitation, as they relate to the use of moisture barriers, installation tools such as nailers and trowels, and the evaluation of job site conditions and moisture testing. The product’s installation and care manual(s) are provided in this document below, and those terms and provisions are part of this limited warranty.

6. WHAT ARE YOUR REMEDIES UNDER THIS LIMITED WARRANTY?

With respect to any defective product during the Limited Warranty Period, we will provide a LL Flooring store credit in the amount of the purchase price paid for the defective portion of the flooring (excluding any installation costs and labor) in excess of the applicable Waste Factor (defined above). A store credit is the sole remedy under this limited warranty and can be used for store product purchases only. Provided, however, we reserve the right, in our sole discretion, to repair or replace such product (or the defective part) free of charge in lieu of a store credit. We will also pay for shipping and handling fees to return the repaired or replacement product to you if we elect to repair or replace the defective product.

This limited warranty applies to the colors, designs, and products available at the time of repair or replacement. If the original flooring is not available, LL Flooring will work with you to substitute a product of similar value. LL Flooring will always try to consider your needs.

We reserve the right to investigate, assess, and validate reported claims by, among other things, requesting samples from you for technical analysis and performing an inspection of the flooring and installation location.

7. HOW DO YOU OBTAIN WARRANTY SERVICE?

To file a warranty claim during the Limited Warranty Period, you may:

- A. Visit the store where you purchased your floor;
- B. Call us at 1-800-366-4204; or
- C. Email via the “contact us” link at www.llflooring.com

Claims must be submitted within the Limited Warranty Period and within ninety (90) days of the date that the problem with the floor is first discovered. No warranty claim will be serviced without contacting us through one of the methods listed above and any such claim must include you providing accurate and complete information in a timely manner.

8. WHAT ARE THE LIMITATIONS OF LIABILITY?

THE REMEDIES DESCRIBED ABOVE IN SECTION 6 ARE YOUR SOLE AND EXCLUSIVE REMEDIES AND OUR ENTIRE LIABILITY FOR ANY BREACH OF THIS LIMITED WARRANTY. NOTWITHSTANDING ANY OTHER PROVISION OR TERM, OF THIS LIMITED WARRANTY OUR LIABILITY SHALL UNDER NO CIRCUMSTANCES EXCEED THE ACTUAL AMOUNT PAID BY YOU FOR THE DEFECTIVE PRODUCT OR DEFECTIVE PORTION THEREOF.

UNDER NO CIRCUMSTANCES SHALL WE BE LIABLE FOR ANY CONSEQUENTIAL, INCIDENTAL, SPECIAL OR PUNITIVE DAMAGES OR LOSSES, WHETHER DIRECT OR INDIRECT. WITHOUT LIMITING THE FORGOING SENTENCE, LOSSES, DAMAGES OR EXPENSES RELATING TO ANYTHING OTHER THAN THE FLOOR ITSELF ARE NOT COVERED, INCLUDING, WITHOUT LIMITATION, DAMAGES DUE TO ANY DELAYS, LOST PROFITS, LOSS OF

BUSINESS, LOSS OF USE OF PREMISES, MISSED TIME FROM WORK, HOTEL STAYS, STORAGE FEES, KENNEL COSTS FOR PETS, REMOVAL OF DEFECTIVE FLOORING, INSTALLATION OF REPLACEMENT FLOORING, OR REMOVAL OR REPLACEMENT OF ITEMS BUILT ON TOP OF ANY FLOORING (FOR EXAMPLE, COUNTERTOPS, CABINETS, BUILT-IN APPLIANCES).

9. TERMS OF DISPUTE RESOLUTION

NO JOINT OR CLASS ACTIONS: Neither you nor LL Flooring shall be entitled to join or consolidate claims in arbitration by or against other customers of LL Flooring with respect to other accounts, bring mass, class action, or consolidated claims in arbitration or a court of competent jurisdiction, or arbitrate or litigate any claim as a representative or individual of a class or in a private attorney general capacity. The arbitrator may not consolidate more than one person's claims and may not otherwise preside over any form of a representative or class proceeding.

ARBITRATION: The following informal dispute resolution procedure is available to you if you believe that we have not performed our obligations under this limited warranty. You must use this informal procedure before pursuing any legal remedy in the courts.

LL Flooring and you agree to attempt to resolve any disputes amicably. If, after thirty (30) days we are unable to do so, then you and LL Flooring each agree that any claim or controversy of any sort relating to our agreement, the Products or these limited warranty terms shall be determined by arbitration in the nearest U.S. city to the LL Flooring store where you purchased the products, before one arbitrator. At the option of the first to commence an arbitration, the arbitration shall be administered either by JAMS pursuant to its Streamlined Arbitration Rules and Procedures, or by the American Arbitration Association pursuant to its Commercial Arbitration Rules. The arbitrator shall have no power to add to, delete from or modify these limited warranty terms. Each of us shall have the right to conduct discovery to which we would be entitled had the dispute been resolved in a state court of general jurisdiction in the state of the LL Flooring store where you purchased the products. Judgment on the arbitrator's award may be entered in any court having jurisdiction. This clause shall not preclude either party from seeking provisional remedies in aid of arbitration from a court of appropriate jurisdiction. The arbitrator may, as part of the award, allocate all or part of the costs of the arbitration, including the fees of the arbitrator and the reasonable attorneys' fees of the prevailing party. The arbitrator shall only have the authority to resolve individual disputes between you and LL Flooring. Notwithstanding the foregoing, in addition to our rights set forth above, we may initiate proceedings directly in the appropriate court located in the U.S. city nearest the LL Flooring store where you purchased the products in connection with any claim to collect amounts due and owing by you.

10. NO OTHER TERMS

SAMPLES, DESCRIPTIONS, AND OTHER INFORMATION CONCERNING THE PRODUCT CONTAINED IN CATALOGS, ADVERTISEMENTS, OR OTHER PROMOTIONAL MATERIAL OR STATEMENTS MADE BY SALES REPRESENTATIVES OR DISTRIBUTORS ARE FOR GENERAL INFORMATIONAL PURPOSES ONLY AND ARE NOT BINDING UPON LL FLOORING. NO SALES

REPRESENTATIVES, STORE MANAGERS, ACCOUNT REPRESENTATIVES, OR DISTRIBUTORS SHALL HAVE ANY AUTHORITY WHATSOEVER TO ESTABLISH, EXPAND OR OTHERWISE MODIFY LL FLOORING WARRANTIES. THE TERMS OF THIS LIMITED WARRANTY DOCUMENT MAY NOT BE AMENDED EXCEPT THROUGH A WRITTEN AGREEMENT TITLED “AMENDMENT TO LIMITED WARRANTY” AND SIGNED BY AN AUTHORIZED OFFICER OF LL FLOORING, PROVIDED, HOWEVER, THAT LL FLOORING MAY GENERALLY MODIFY, CANCEL, UPDATE, OR OTHERWISE CHANGE ITS PROSPECTIVE WARRANTIES FOR FUTURE SALES AT ANY TIME AND FOR ANY REASON.

11. OTHER PROVISIONS

The section headings provided in this limited warranty are for convenience and informational reference only and shall not affect the interpretation or construction of this limited warranty.

THE PROVISIONS OF THIS LIMITED WARRANTY ARE DEEMED TO BE SEVERABLE AND THE INVALIDITY OR UNENFORCEABILITY OF ONE PROVISION SHALL NOT AFFECT THE VALIDITY OR ENFORCEABILITY OF ANY OTHER PROVISION.

12. ADDRESS FOR LL FLOORING

LL Flooring, Inc. is located at 4901 Bakers Mill Lane, Richmond, VA 23230.

[HOME](#)